

COPY 1

Report No. FAA-RD-77-26

GENERAL AVIATION PILOT STALL AWARENESS TRAINING STUDY

**William C. Hoffman
Walter M. Hollister**

**NAFPC
LIBRARY
JUL 1 77**



SEPTEMBER 1976

FINAL REPORT

Document is available to the U.S. public through
the National Technical Information Service,
Springfield, Virginia 22161.

Prepared for

**U.S. DEPARTMENT OF TRANSPORTATION
FEDERAL AVIATION ADMINISTRATION
Systems Research & Development Service
Washington, D.C. 20590**

NOTICE

This document is disseminated under the sponsorship of the Department of Transportation in the interest of information exchange. The United States Government assumes no liability for its contents or use thereof.

1. Report No. FAA-RD-77-26		2. Government Accession No.		3. Recipient's Catalog No.	
4. Title and Subtitle GENERAL AVIATION PILOT STALL AWARENESS TRAINING STUDY				5. Report Date September 1976	
				6. Performing Organization Code	
7. Author(s) William C. Hoffman, Walter M. Hollister				8. Performing Organization Report No. ASI-TR-76-37	
9. Performing Organization Name and Address Aerospace Systems, Inc. One Vine Brook Park Burlington, Massachusetts 01803				10. Work Unit No.	
				11. Contract or Grant No. DOT-FA75WA-3716	
12. Sponsoring Agency Name and Address U.S. Department of Transportation Federal Aviation Administration Systems Research & Development Service Washington, DC 20590				13. Type of Report and Period Covered Final Report June 1975 - August 1976	
				14. Sponsoring Agency Code ARD-530	
15. Supplementary Notes					
16. Abstract <p>Stall/spin accidents involving general aviation aircraft account for a large number of fatal and serious injuries. In an effort to reduce this accident rate, focus is placed on the potential of enhanced pilot training in the areas of stall/spin recognition, avoidance, and recovery.</p> <p>The objective of this study was to determine the weaknesses of present flight training syllabi, the methods of training used, and the flight instruction presently provided in the stall/spin area; conceive an experimental stall/spin increment to an established flight and ground training syllabus; and conduct flight and ground test evaluations of this syllabus change and the flight instruction techniques required.</p> <p>Volunteer student pilots were divided into four groups for the evaluation procedure: Group 1 was the control group, and received no additional stall/spin instruction; Group 2 received additional ground instruction in stalls/spins; Group 3 received two hours of flight instruction on stall and spin avoidance in addition to the ground school increment; Group 4 was given the same instruction as Group 3 plus training in intentional spins. Evaluation flight tests were conducted prior to and after the training period.</p> <p>Results indicate that additional ground training in the subject of stalls and spins, additional flight training on stall awareness, and/or intentional spin training would all have a positive influence toward reducing inadvertent stalls and spins.</p>					
17. Key Words General Aviation, Pilot Training, Flight Instruction, Stall/Spin, Ground Training			18. Distribution Statement Document is available to the public through the National Technical Information Service, Springfield, Virginia 22161.		
19. Security Classif. (of this report) Unclassified		20. Security Classif. (of this page) Unclassified		21. No. of Pages 264	22. Price

METRIC CONVERSION FACTORS

Approximate Conversions to Metric Measures

Symbol	When You Know	Multiply by	To Find	Symbol
LENGTH				
in	inches	2.5	centimeters	cm
ft	feet	30	centimeters	cm
yd	yards	0.9	meters	m
mi	miles	1.6	kilometers	km
AREA				
in ²	square inches	6.5	square centimeters	cm ²
ft ²	square feet	0.09	square meters	m ²
yd ²	square yards	0.8	square meters	m ²
mi ²	square miles	2.6	square kilometers	km ²
	acres	0.4	hectares	ha
MASS (weight)				
oz	ounces	28	grams	g
lb	pounds	0.45	kilograms	kg
	short tons (2000 lb)	0.9	tonnes	t
VOLUME				
tsp	teaspoons	6	milliliters	ml
Tbsp	tablespoons	15	milliliters	ml
fl oz	fluid ounces	30	milliliters	ml
c	cup	0.24	liters	l
pt	pints	0.47	liters	l
qt	quarts	0.95	liters	l
gal	gallons	3.8	liters	l
ft ³	cubic feet	0.03	cubic meters	m ³
yd ³	cubic yards	0.76	cubic meters	m ³
TEMPERATURE (exact)				
°F	Fahrenheit temperature	5/9 (after subtracting 32)	Celsius temperature	°C

*1 in = 2.54 (exactly). For other exact conversions and more detailed tables, see NBS Misc. Publ. 286, Units of Weights and Measures, Price \$2.25, SD Catalog No. C13.10:286.

Approximate Conversions from Metric Measures

Symbol	When You Know	Multiply by	To Find	Symbol
LENGTH				
mm	millimeters	0.04	inches	in
cm	centimeters	0.4	inches	in
m	meters	3.3	feet	ft
m	meters	1.1	yards	yd
km	kilometers	0.6	miles	mi
AREA				
cm ²	square centimeters	0.16	square inches	in ²
m ²	square meters	1.2	square yards	yd ²
km ²	square kilometers	0.4	square miles	mi ²
ha	hectares (10,000 m ²)	2.5	acres	
MASS (weight)				
g	grams	0.035	ounces	oz
kg	kilograms	2.2	pounds	lb
t	tonnes (1000 kg)	1.1	short tons	
VOLUME				
ml	milliliters	0.03	fluid ounces	fl oz
l	liters	2.1	pints	pt
l	liters	1.06	quarts	qt
l	liters	0.26	gallons	gal
m ³	cubic meters	35	cubic feet	ft ³
m ³	cubic meters	1.3	cubic yards	yd ³
TEMPERATURE (exact)				
°C	Celsius temperature	9/5 (then add 32)	Fahrenheit temperature	°F



FOREWORD

This report was prepared by Aerospace Systems, Inc. (ASI), Burlington, Massachusetts, for the Department of Transportation (DOT) under Contract No. DOT-FA75WA-3716. The report documents the results of research performed during the period June 1975 to August 1976. This study was sponsored by the Federal Aviation Administration (FAA), Systems Research and Development Service, Washington, D.C. Mr. Patrick E. Russell served as Technical Officer for the contract.

The effort was directed by Mr. William C. Hoffman as the ASI Project Engineer. Mr. Melvin S. Garelick participated as a coinvestigator during the initial phases of the program. Dr. Walter M. Hollister of the MIT Department of Aeronautics and Astronautics served as principal technical consultant and also as a coinvestigator. Dr. Renwick E. Curry of the MIT Man-Vehicle Laboratory, and Mr. Jack D. Howell and Ms. Sandra Rush of the ASI staff also contributed to the study.

The authors are grateful to all the participants in the program, especially the subject pilots and instructors. We also wish to acknowledge the cooperation of Mr. Kenneth Gero of Nashua Aviation under the New England Aeronautical Institute, Nashua, New Hampshire; and of Mr. James O'Hearn and Mr. Gary Keighley of Wiggins Airways, Norwood, Massachusetts.

TABLE OF CONTENTS

<u>Section</u>		<u>Page</u>
1	INTRODUCTION	1
	1.1 Research Objectives	1
	1.2 Report Organization	2
2	BACKGROUND	3
	2.1 General Aviation Stall/Spin Accident Record	3
	2.2 Flight Training of Stalls and Spins	7
	2.3 Survey of Stall/Spin Experience in Present Pilot Training	11
	2.4 Stall Awareness Program Philosophy	12
	2.5 Flight Instructor Opinions.	14
	2.6 Experiment Description	15
	2.6.1 Program Organization	15
	2.6.2 Experiment Overview	16
3	STALL AWARENESS TRAINING SYLLABUS INCREMENT . .	17
	3.1 Ground Training Increment	17
	3.2 Flight Training Increment Description	17
	3.2.1 Scenarios	20
	3.2.2 Flight at Minimum Controllable Airspeed/ High Angle of Attack	24
	3.2.3 Incipient Spins, Spin Avoidance, and Spin Training	25
	3.3 Flight Training Increment Syllabus	25
	3.3.1 Preflight	26
	3.3.2 First Flight Lesson	26
	3.3.3 Second Flight Lesson	27

TABLE OF CONTENTS (Continued)

<u>Section</u>		<u>Page</u>
4	FLIGHT EVALUATION	29
	4.1 Flight Description	29
	4.2 Instructions to the Subject Pilot	30
	4.3 Detailed Evaluation Flight Plan	32
	4.4 Evaluation Flight Scoring	33
5	DATA ANALYSIS	37
	5.1 Data Scoring and Recording	37
	5.2 Basic Statistical Processing	38
	5.3 Analysis of Variance	43
	5.4 Correlation Analysis	49
6	MAJOR RESULTS AND CONCLUSIONS	53
	6.1 Major Results	53
	6.2 Conclusions	56
	REFERENCES	59
	BIBLIOGRAPHY	61
 <u>Appendices</u>		
A	STALL AWARENESS PROGRAM NOTES	A-1
	1. Description of the Stall Awareness Training Program ...	A-2
	2. General Aviation Stall Spin Accidents	A-4
	3. Spins	A-13
	4. Stall Avoidance	A-18
	5. Intentional Spins	A-27
	6. Stall and Spin Training	A-36

TABLE OF CONTENTS (Continued)

<u>Appendices</u>	<u>Page</u>
7. Spin Testing and Certification of Aircraft	A-59
8. Aerodynamics	A-65
B WRITTEN QUIZZES	B-1
C EXPERIMENTAL RESULTS	C-1
D SUMMARY STATISTICS OF STALL AWARENESS RESULTS	D-1
E ADDITIONAL MULTIVARIATE ANALYSES	E-1

LIST OF ILLUSTRATIONS

<u>Figure</u>		<u>Page</u>
1	General Aviation Accident Trends	4
2	Evaluation Flight Scoring Form	35
3	Sample Computer Input Data Form	39
4	Histograms of Subjective Overall Grades for First Evaluation Flight (Variable No. 45)	44
5	Histograms of Subjective Overall Grades for Second Evaluation Flight (Variable No. 74)	46
A-1	Illustration of Spinning Motion	A-14
A-2	Balance of Forces in a Spin	A-16
A-3	Balance of Aerodynamic and Inertia Pitching Moments in a Spin	A-17
A-4	Correctly Coordinated, Skidding and Slipping Left Turns	A-50
A-5	Airfoil Terminology	A-66
A-6	Aircraft Axes and Motions	A-68
A-7	Level Flight - 100 MPH	A-70
A-8	Climb - 100 MPH	A-70
A-9	Descent - 100 MPH	A-70
A-10	Aircraft in Level Flight	A-71
A-11	Stall at High Airspeed in Pullout from a Dive	A-72
A-12	Lift and Relative Wind in a Loop	A-74
A-13	Lift Coefficient vs. Angle of Attack	A-75
A-14	Drag Coefficient vs. Angle of Attack	A-75
A-15(a)	Lift Coefficient vs. Angle of Attack	A-80
A-15(b)	Drag Coefficient vs. Angle of Attack	A-80
A-16	Changes in Angle of Attack due to Rolling Velocity	A-81
A-17	Drag vs. Airspeed	A-86
A-18	Power vs. Airspeed	A-86

LIST OF TABLES

<u>Table</u>		<u>Page</u>
1	Most Frequent Accident Types (1970)	5
2	Outline for Ground School Lectures	18
3	Examples of Distraction Scenarios	30
4	Stall Awareness Program Participation Summary	37
5	Definition of Statistical Analysis Variables	41
6	One-Way Anova of Selected Variables Prior to Training Increment	48
7	Summary of Anova Confidence Levels	50
8	Correlation Matrix for Selected Observation Variables	51
9	Improvement in Unintentional Stalls, Spins, and Takeovers	54
E-1	Major Elements of the Sorted Factor Matrix (80 Percent Variance)	E-2
E-2	Discriminant Function Results With Experience Data	E-4
E-3	Discriminant Function Results Without Experience Data	E-5
E-4	Discriminant Function Results for Training Aircraft Type	E-5

NOMENCLATURE

anova	Analysis of variance
AC	Advisory Circular
A/C	Aircraft
AGL	Above ground level
ASI	Aerospace Systems, Inc.
c	Chord; straight line distance between leading and trailing edges of airfoil.
c.g.	Center of gravity
CAA	Civil Aeronautics Agency (Predecessor of FAA)
CAR	Civil Aeronautics Regulation
CFI	Certified Flight Instructor
C_D	Drag coefficient; describes how drag varies with angle of attack
C_L	Lift coefficient; describes how lift varies with angle of attack
C_{Lmax}	Maximum value of lift coefficient
D	Drag on wing or airplane; force which tends to retard motion through air
DOF	Degrees of freedom
DOT	Department of Transportation
F	F ratio; statistic which measures how well data fit hypothesis
FAA	Federal Aviation Administration
FAR	Federal Aviation Regulation
FSS	Flight Service Station
L	Lift on wing or airplane; force which "lifts" aircraft
mph	Miles per hour
MCA	Minimum controllable airspeed
MIT	Massachusetts Institute of Technology
MSL	Mean sea level
NASA	National Aeronautics and Space Administration

NEAI	New England Aeronautical Institute
NTSB	National Transportation Safety Board
P	Probability that data differ from standard tables of F distribution
q	Dynamic pressure; pressure caused by airflow impacting on an aircraft
rpm	Revolutions per minute
RW	Relative wind
S	Surface area of wing
TAS	True airspeed
TT	Total time
TV	Television
V	Airspeed
V_{\max}	Maximum possible airspeed for level flight
V_{\min}	Minimum possible airspeed for level flight
$V_{\min \text{ drag}}$	Airspeed for minimum drag or maximum range
$V_{\min \text{ power}}$	Airspeed at which change from normal to reverse commands occurs
V_{S_0}	Flaps-down stalling speed
V_{S_1}	Flaps-up stalling speed
V_y	Airspeed at which difference between available and required power is largest, producing maximum rate of climb
VFR	Visual flight rules
VTR	Video tape recorder
α	Angle of attack ; angle formed by direction of relative wind (or the flight path) and chordline of the airfoil
α_{Stall}	Stalling angle of attack; angle of attack which corresponds to maximum value of lift coefficient
γ	Flight path angle; angle between horizontal and flight path
Δ	Change in score between first and second evaluation flights
θ	Pitch attitude; angle between horizontal and aircraft longitudinal axis

ν_H	Hypothesis degrees of freedom used in analysis of variance
ν_R	Residual degrees of freedom used in analysis of variance
ρ	Atmospheric density
ρ_{ij}	Element of correlation matrix; measures linear association between two respective variables ($-1 \leq \rho_{ij} \leq +1$)
χ^2	Non-parametric statistic used as a test of significance

SECTION 1 INTRODUCTION

1.1 RESEARCH OBJECTIVES

Stall/spin accidents involving general aviation aircraft have historically accounted for more fatal and serious injuries than any other single type of accident (Reference 1). Although improvement has been evidenced over the past several decades, these types of occurrences still remain a very serious threat to safety in general aviation. Ever increasing public acceptance and utilization of the airplane make a significant reduction of these accidents not merely a statistical goal, but a social, political, and economic one as well. Because of the large increase in fleet size and total flight exposure anticipated during the next decade, the number of stall/spins may be expected to escalate. In view of this, the National Transportation Safety Board (NTSB) presented a number of recommendations in Reference 1 intended to reduce stall/spin occurrences. As discussed in the next section, many of these recommendations focused on the potential of enhanced pilot training for reducing stall/spin accidents in general aviation.

An experimental effort conducted by the Massachusetts Institute of Technology (MIT) (Reference 2), found that pilot skills receiving the lowest average grades involved stalls and simulated instrument flight. That study revealed that most of the participating pilots had obtained little or no practice in stalls since their initial training.

There are indications that the civil pilot training process and the product of this process, the pilot and his performance, can be improved in a number of areas. Of primary interest in this study is stall/spin recognition, avoidance, and recovery. In addition, it is felt that the flight instructor can play an important role in reducing the occurrence of stall/spin accidents.

In light of the above, a concerted investigation of the stall/spin problem through improved training methods and flight instruction was undertaken by the FAA. The purpose of the ASI Stall Awareness Training Study was to provide research data in support of FAA programs to reduce occurrences of stall/spin accidents in general aviation. Specifically, the ASI experimental study had the following primary objectives:

- Conduct background investigations to isolate the weaknesses of present flight training syllabi, the methods of training used, and the flight instruction provided in the stall/spin area.

- Conceive an experimental stall/spin increment to an established flight and ground training syllabus designed to provide a quantum increase in the student pilot's understanding of the multitudinous implications of near stall flight and to establish the basis for improved flight instruction.
- Conduct flight and ground test evaluations of this syllabus change and the flight instruction techniques required.

1.2 REPORT ORGANIZATION

The remainder of the report describes the ASI Stall Awareness Training Study and the results obtained. Section 2 provides some background material on general aviation stall/spin accidents, and reviews present and previous stall/spin pilot training procedures. An overview of the study is also presented in Section 2, including the philosophy, organization, participants, training increments, evaluation procedures, and data analysis.

Section 3 describes the ground and flight training increments in more detail. The development and implementation of the flight evaluation program are discussed in Section 4. The data processing and statistical analysis techniques are outlined in Section 5. Section 6 summarizes the experimental results and conclusions.

Additional detailed information is provided in five appendices: Appendix A presents the handbook developed for the ground training increment; Appendix B contains the written quizzes and answers; Appendix C summarizes the evaluation flight scores; Appendix D presents statistical summary data; and Appendix E describes two additional statistical analyses.

SECTION 2 BACKGROUND

2.1 GENERAL AVIATION STALL/SPIN ACCIDENT RECORD

More fatal and serious injuries have occurred from stall/spin accidents involving general aviation aircraft than from any other single type of accident (Reference 1). The percentages fluctuate from year to year, but usually between 20 and 25 percent of the fatal accidents are stall/spin related. According to NTSB figures for 1973, general aviation accounted for 4,180 total accidents, 701 of which resulted in 1,340 fatalities. The trends over recent years are shown in Figure 1. In reviewing the aircraft accident statistics, one should note that the definition of an accident was changed January 1, 1968. This change increased the level of aircraft damage necessary to qualify as an accident, thus decreasing the apparent number of accidents.

An overview of the 4,712 accidents which general aviation experienced in 1970 reveals some interesting facts: 14 percent of the accidents were fatal, 8 percent resulted in serious injury, and 14 percent resulted in minor injury. Of the aircraft involved in these accidents, 21 percent were destroyed and 77 percent were damaged substantially. Of the 9,935 persons aboard the aircraft involved in accidents in 1970, 13 percent were injured fatally, 7 percent were injured seriously, 12 percent received minor injuries, and 68 percent were not injured.

The aircraft hours flown by U.S. general aviation aircraft in 1970 were nearly double those of 1961. During the same period, the accident rate per 100,000 aircraft hours flown had a downward trend. Table 1 shows the most frequent causes of fatal and non-fatal accidents in general aviation in 1970. Note in Table 1 that "Failed to obtain/maintain flying speed" was cited as a cause in 26 percent of the fatal accidents. Obviously, the kind of flying influences the pilots' accident exposure; pleasure flying consistently had the highest total accident rate each year, followed by aerial application and instructional flying. Pleasure flying fatal accident rates are significantly higher than those in the other categories. An examination of the statistics reveals that the major cause of fatalities in general aviation is in the category of stalls, spins, and spirals. These statistics show that pilot knowledge, training and skills related to this category of aviation accident are clearly inadequate. Detailed computerized statistics

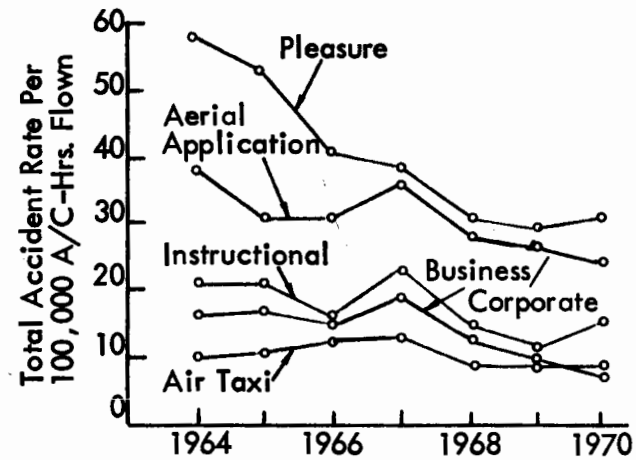
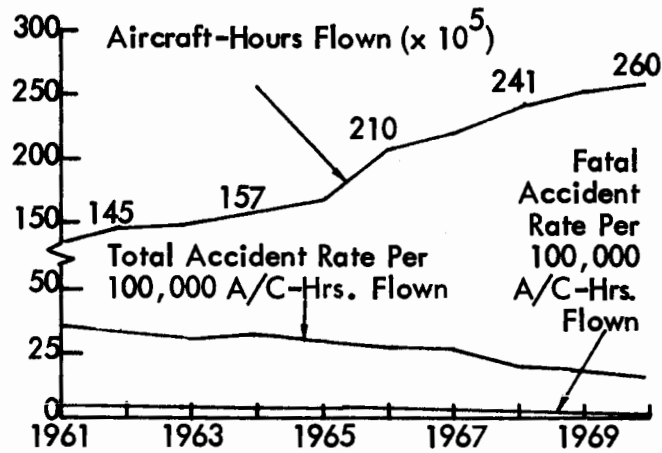
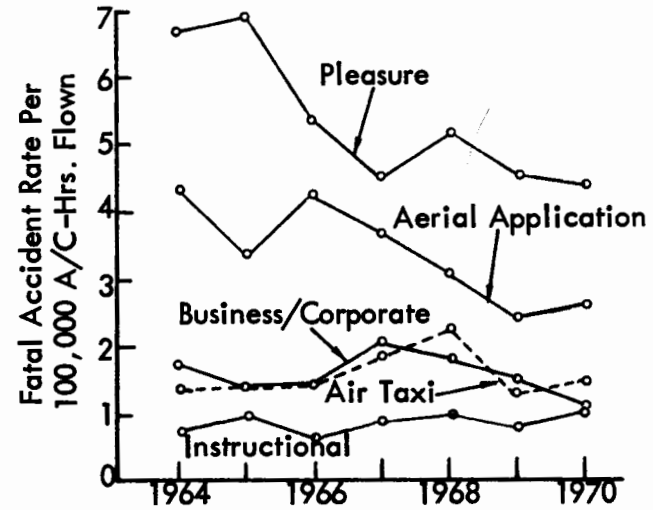
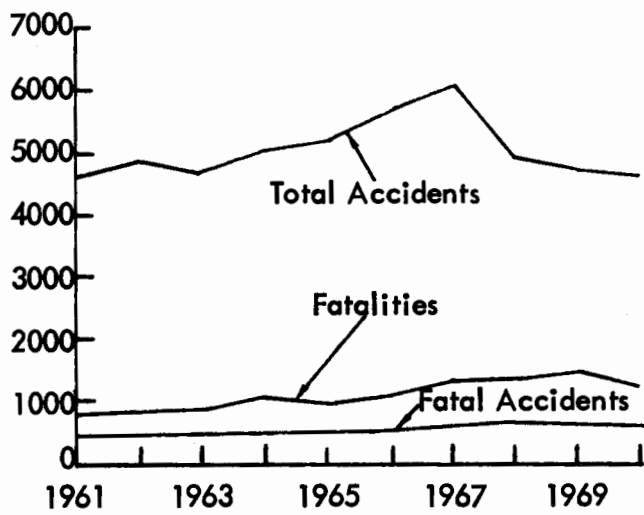

FIGURE 1. GENERAL AVIATION ACCIDENT TRENDS.

TABLE 1. MOST FREQUENT ACCIDENT TYPES (1970).

A. Ten Most Frequent Types of Accidents in 1970. (Based on 4712 Total Accidents).	
Type of Accident	Percent of Total
1) Engine failure or malfunction	21.4
2) Ground/water loop swerve	13.9
3) Hard Landing	7.6
4) Stall	4.8
5) Overshoot	4.2
6) Stall mush	3.8
7) Collision with trees	3.8
8) Undershoot	3.7
9) Collisions with ground/water, controlled	3.7
10) Collisions with ground/water, uncontrolled	3.7
B. Ten Most Frequently Cited Causes of Fatal Accidents in 1970. (Based on 630 Fatal Accidents).	
Causal Citations	Percentage of Fatal Accidents
1) Failure to obtain/maintain flying speed	25.9
2) Continued VFR flight into adverse weather conditions	19.7
3) Spatial disorientation	14.9
4) Miscellaneous undetermined	10.3
5) Inadequate preflight preparation or planning	8.9
6) Unwarranted low flying	6.4
7) Pilot of other aircraft (collisions between aircraft)	5.6
8) Exercise of poor judgment	5.6
9) Failure to see and avoid other aircraft (collisions between aircraft)	5.1
10) Improper in-flight decisions or planning	4.4
C. Ten Most Frequently Cited Causes of Nonfatal Accidents in 1970. (Based on 4019 Nonfatal Accidents).	
Causal Citations	Percentage of Nonfatal Accidents
1) Inadequate preflight preparation or planning	10.8
2) Failed to obtain/maintain flying speed	9.2
3) Failed to maintain directional control	8.6
4) Improper level off	8.4
5) Selected unsuitable terrain	7.7
6) Powerplant failure for undetermined reasons	5.9
7) Mismanagement of fuel	5.6
8) Exercised poor judgment	5.1
9) Terrain - rough/uneven	4.9
10) Material failure	4.8

on general aviation stall/spin accidents are presented in the NTSB special study adopted in 1972 (Reference 1). Following is a summary of the results presented in that report:

- A total of 1,261 stall/spin accidents were recorded during the three-year period covered by this study, 1967 through 1969. These accounted for only 8 percent of the total number of accidents, but were responsible for 997 fatalities and 464 serious injuries — about 24 percent of the total of all fatal or serious accident injuries sustained during this period.
- Sixty-one percent of all stall/spin accidents reviewed were associated with non-commercial flying; 19 percent were associated with instructional flying; 14 percent were associated with commercial flying; and 7 percent were associated with flying of a miscellaneous kind.
- Twenty-four percent of the stall/spin accidents occurred during takeoff; 36 percent occurred during landing; and 40 percent occurred during the inflight phase. Most of the accidents in this latter phase were related to "acrobatics," "buzzing," "low passes," etc.
- The pilot was considered a broad cause/factor in about 97 percent of the 744 occurrences in which a stall/spin was considered to be the primary accident type.
- Significant miscellaneous acts and conditions associated with first type stall/spin accidents included "unwarranted low flying," "flew into blind canyon," "poorly planned approach," "alcoholic impairment of efficiency and judgment," "improperly loaded aircraft, weight, and/or c.g.," etc.
- Two hundred and forty-seven or about 25 percent, of the 991 stall/spin accidents reviewed were preceded by other types of occurrences (other types of accidents), including 190 engine failures or malfunctions.
- The broad cause/factor categories assigned to the above engine failure/malfunction accidents included the pilot in 54 percent of the cases, the powerplant in 39 percent of the cases, and personnel in about 13 percent of the cases.
- Significant miscellaneous acts and conditions relating to the engine failure/malfunction accidents included "anti-icing/deicing equipment - improper operation of/failed to use," "fuel exhaustion," "ice-carburetor," "simulated conditions," "fuel starvation," etc.
- Application of the Chi-Square statistical method to the study fleet disclosed that eight single-engine airplanes and one twin-engine airplane had a frequency of occurrence of stall/spin accidents that was statistically significant at the 0.1 percent level.

Based on the special stall/spin accident study in Reference 1, the NTSB made nine specific recommendations, including the following for flight training:

STALL/SPIN STATISTICS

A. THE ACCIDENT RECORD

During the post World War II period, 1945 through 1948, stall/spin accidents accounted for about 48 percent of all fatal general aviation accidents. For the three year period 1967 through 1969, they accounted for 22 percent of all fatal occurrences. The 1,261 stall/spin accidents recorded during this time resulted in only about 8 percent of the total number of accidents but were responsible for 997 fatalities and 464 serious injuries, about 23.5 percent of the total of all fatal or serious accident injuries sustained during this period.

According to one study, by 1980 the general aviation fleet will number close to a quarter of a million aircraft, more than double the size of the 1967 fleet, and will fly about 63 million hours annually, about three times the total flight hours recorded in 1967. Thus, although a substantial relative improvement in stall/spin accident statistics appears to have been evidenced in past years, the increased size and growth rate of general aviation makes further improvement imperative.

B. PILOT CERTIFICATE/WEATHER CONDITIONS/LIGHTING CONDITIONS

The pilots involved in 991 of the stall/spin accidents, according to certificate, included 166 students, 425 private pilots, 203 commercial pilots, 163 commercial flight instructors, and 34 others. 956 of the accidents occurred during VFR weather conditions, 29 during IFR conditions, 5 in conditions unknown or not reported, and 1 in conditions below minimums. 892 of the accidents occurred during daylight, 54 at night, 40 at dusk, 4 at dawn, and 1 in unknown or unreported lighting conditions.

C. KIND OF FLYING

60.5 percent of all the stall/spin accidents studied were associated with non-commercial flying, primarily related to pleasure, practice, and business flights. 19 percent were associated with instructional dual, solo, and training flights. 14 percent were associated with commercial flying, principally in connection with aerial application or crop-control, and the remaining 6.5 percent involved flights of a miscellaneous kind.

D. PHASE OF OPERATION

238, or 24 percent, of the stall/spin accidents occurred during the takeoff phase of flight, all but one of these occurring during the initial climb. 395, or 40 percent, occurred during the in-flight phase, but only 70 of these, or 7 percent of the study group, could be accounted for in the specific phases described as "climb to cruise," "normal cruise," and "descending." The other 325 in-flight accidents, in all except four cases, were associated with "acrobatics," "buzzing," "low passes," agricultural and various other operations. The remaining 358 stall/spin accidents, or 36 percent of the study group, occurred during the landing phase of flight, with most related specifically to "traffic pattern-circling," "final approach," and "go-around."

Fatal stall/spins numbered 73 in the takeoff phase, 107 in the landing phase, and 235 in the in-flight phase. The ratio of fatal stall/spin occurrences to the total number of stall/spin occurrences within a given phase of flight was approximately the same in both takeoff and landing (about 30 percent). In the in-flight phase, however, this ratio was about twice as great (about 60 percent).

E. STALL/SPIN ACCIDENT SEQUENCE

In 744 of the 991 accidents, the stall/spin was cited as a first accident type. The remaining 247 stall/spins were classified as second accident types, i.e., they were

preceded by other occurrences, including 190 engine failure/malfunctions, 25 overshoots, 10 undershoots, 8 groundloops, 9 hard landings, and 5 other miscellaneous accident types. Approximately 43 percent of the engine failure/malfunctions occurred during the takeoff phase of flight, almost all of these during the initial climb; 43 percent occurred during various in-flight phases; and 14 percent during various landing phases.

F. BROAD AND DETAILED CAUSES AND FACTORS

The pilot was considered a broad cause/factor in about 97 percent of the first type stall/spin accidents and is cited most frequently in connection with failure to obtain/maintain flying speed. The latter was recorded as a detailed cause/factor in 667 of these cases. Numerous other significant but less frequently related detailed cause/factors involving the pilot included "attempted operation beyond experience/ability level," "diverted attention from operation of aircraft," "continued VFR flight into adverse weather conditions," "inadequate preflight preparation and/or planning," "improper operation of flight controls," "improper in-flight decisions or planning," "exercised poor judgment," "inadequate supervision of flight," "physical impairment," and "misused or failed to use flaps." Another rather significant broad cause/factor was weather, which was related to about 16 percent of these first type stall/spins. The details were associated with cause/factors such as "low ceilings," "fog," "icing conditions," "unfavorable wind conditions," "down-drafts," "updrafts," "high temperature," "high density altitude," etc. The broad cause/factor "miscellaneous" was associated with about 4 percent of the cases and included detailed cause/factors such as "evasive maneuver to avoid collision," and "unqualified person operating aircraft."

Certain other miscellaneous acts and conditions associated with the aforementioned accidents are also considered significant. These include "unwarranted low flying" (in 106 instances), "poorly planned approach," "flew into blind canyon,"

"alcoholic impairment of efficiency and judgment," and "improperly loaded aircraft-weight and/or c.g."

The pilot was considered to be a broad cause/factor in about 54 percent of the 190 engine failure/malfunction type accidents preceding stall/spins. The detailed cause/factors tabulated most frequently were "improper operation of powerplant and powerplant controls," "inadequate preflight preparation and/or planning," and "mismanagement of fuel." Other broad cause/factor categories included the powerplant, cited in about 39 percent of the cases, with "powerplant failure for undetermined reasons" being detailed in about half of all such instances; personnel, cited in about 13 percent of the cases, primarily in connection with "inadequate maintenance and inspection;" "weather" in about 8 percent of the cases, with "conditions conducive to carburetor/induction system icing" being the most frequently tabulated detail; and miscellaneous in about 5 percent of the cases. The miscellaneous acts and conditions most frequently tabulated in connection with these engine failure/malfunction type accidents were "anti-icing/deicing equipment - improper operation of/failed to use," "fuel exhaustion," "ice-carburetor," "simulated conditions," and "fuel starvation."

The broad cause/factors associated with the remaining types of accidents preceding stall/spins, i.e., overshoot, undershoot, groundloop, etc., are related primarily to the pilot and weather.

PILOT INVOLVEMENT SUMMARY

Some years ago a review of FAA airmen examinations suggested that the stall/spin problem appears partially related to a lack of knowledge and awareness of factors affecting a stall. It is also evident, however, based on the correlation of stall/spin accidents with "phase of flight," that the majority of stall/spins occur under conditions which distract the pilot and substantially divide his total attention

between performance and control of the airplane and external references, operational contingencies, etc. 60 percent of the stall/spins studied, for example, occurred during takeoff and landing, and 33 percent during in-flight acrobatics, buzzing, low passes, etc.

In connection with airplane performance, it should be noted that many of these stall/spins were precipitated by an engine failure or malfunction caused by mismanagement of fuel, improper operation of powerplant and powerplant controls, and inadequate preflight preparation and/or planning.

The pilot's attentiveness to airplane performance in terms of monitoring and controlling airspeed and responding to stall warning is often compromised by contingencies and critical circumstances which develop as a direct result of his own actions, e.g., unwarranted low flying, misuse of flaps, poorly planned approach, and inadequate preflight preparation and/or planning. These factors, as well as those relating to the above-mentioned occurrences of engine failure/malfunction, relate generally to pilot competence, proficiency, education, and judgment.

Some specific examples of pilot-involved factors, circumstances, and conditions which, based on a review of selected accidents, are related directly or indirectly to the stall/spin occurrence include:

- unwarranted low flying
- fuel exhaustion due to inadequate preflight preparation and/or planning
- fuel starvation due to mispositioning of fuel selector
- alcoholic impairment of efficiency and judgment
- poorly planned approach
- lack of familiarity with aircraft

- continuing VFR flight into adverse weather conditions
- diverted attention from operation of aircraft
- water in fuel
- premature lift-off
- improperly loaded aircraft—weight and/or c.g.
- inadequate soft- or short-field technique
- attempting takeoff from unimproved or inadequate fields
- attempting takeoff or go-around with wing flaps improperly extended
- inadequate landing go-around technique
- inadequate crosswind takeoff or landing technique
- abortive attempts to clear obstacles
- poor judgment and/or technique in simulated forced landings
- general lack of proficiency in takeoff or landing during windy, turbulent conditions.

SECTION 3

SPINS

WHAT IS A SPIN?

The spin has been defined as an aggravated stall which results in autorotation. It is a motion in which an airplane whose wing is in a stalled condition descends rapidly towards the earth in a helical path, rotating about a vertical axis. Wing angles of attack in the spin are between stalling and 90° . Associated pitch attitudes may vary from level to vertically nose down to slightly inverted. The spinning motion is very complicated and involves simultaneous rolling, yawing, and pitching while the airplane is at high angles of attack and sideslip. Since it involves separated flows in the region beyond the stall, aerodynamic characteristics of the airplane are very nonlinear and time dependent. Thus, at the present time, the spin is not very amenable to theoretical analyses.

The overall spin maneuver can be considered to consist of three phases: the incipient spin, the developed spin, and the recovery.* An illustration of the various phases of the spinning motion is given in Figure A-1.

The incipient spin occurs from the time the airplane stalls and rotation starts until the spin axis becomes vertical or nearly vertical. During this time the airplane flight path is changing from horizontal to vertical, and the spin rotation is increasing from zero to the fully developed spin rate. The incipient spin usually occurs rapidly in light airplanes (4 to 6 seconds, approximately) and consists of approximately the first two turns. As indicated by full-scale tests and by the model tests, the typical incipient-spin motion starts during the stall with a roll-off. Then, as the nose drops the yawing motion begins to build up. About the half-turn point, the airplane is pointed almost straight down but the angle of attack is usually above that of the stall because of the inclined flight path (see Figure A-1). As the one-turn point is approached, the nose

*Bowman, J. S., Jr.: Summary of Spin Technology as Related to Light General Aviation Airplanes. NASA TND-6575, December 1971.

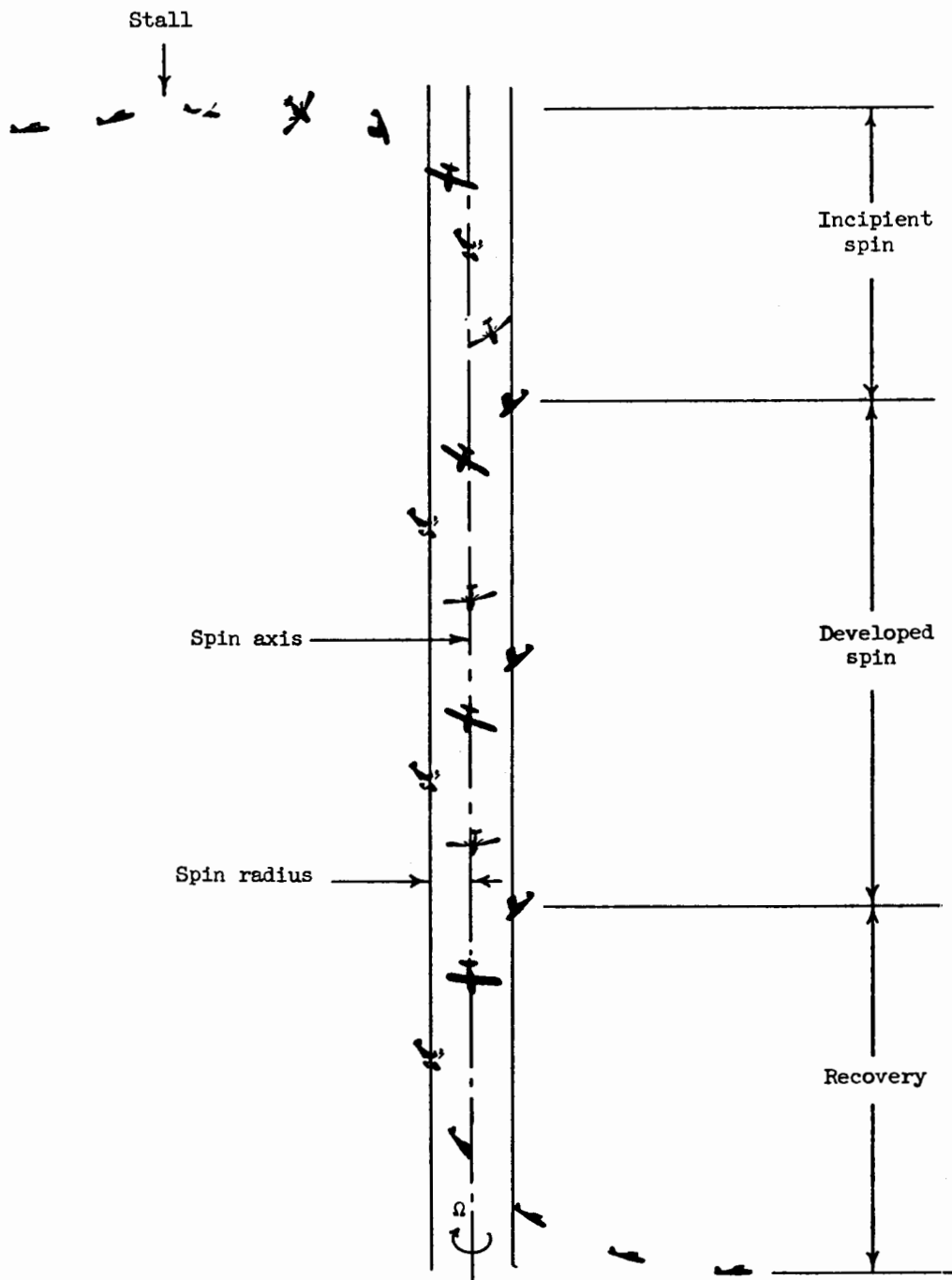

(a) Complete spin, stall through recovery.

FIGURE A-1. ILLUSTRATION OF SPINNING MOTION.

A relatively common reaction among these instructors was a reluctance to give spin training because they felt it would frighten their students. Even those instructors who do teach spins do so only to selected students who they feel can handle them without being frightened. Some interesting comments were made by a civilian flight instructor who has given over 8000 hours of instruction, trained some 400 pilots, and acted as a designated examiner for 3 years, issuing some 80-90 licenses. He likes to teach spins and asks all his students if they want spin instruction. Of all these students, only about 20 have accepted spin instruction. He thought that spin training and aerobatic instruction are valuable for pilots but did not feel it was practical to require such training for most students. He also related an incident during which he was demonstrating a spin in an approved and properly loaded airplane, which did not respond when normal recovery controls were first applied. Recovery finally was made at an altitude of 1200 feet from an entry at 5000 feet, and he did not spin again for a considerable period of time. To improve the quality of flight instruction, he suggested that all prospective instructors be required to attend some kind of national flight instructor school.

2.6 EXPERIMENT DESCRIPTION

This subsection provides an overview of the organization and operation of the Stall Awareness Training Study. More detailed discussions of the training increments, flight evaluations, and data analyses are presented in subsequent sections.

2.6.1 Program Organization

The Stall Awareness Training Study was conducted by ASI as prime contractor to the FAA. Subcontracts were awarded to Wiggins Airways, Norwood, Massachusetts, and to New England Aeronautical Institute (NEAI), Nashua, New Hampshire, who provided the student pilot subjects, aircraft, and flight instruction. Both subcontractors offer two-year, associate degree flight programs in aviation technology, which feature scheduled formal classes and flight instruction. The advantages of formal schools are the availability of a group of student pilots with similar experience levels, and more importantly, a significant degree of schedule control over the students.

Two flight schools were chosen since neither one alone could provide enough subject pilots. This had both advantages and disadvantages. Although both schools are about the same distance from ASI, the administrative and logistical effort was increased. Also, the two schools use different types of aircraft for their flight instruction;

Wiggins uses the Piper Cherokee PA-28, while NEAI uses the Cessna Commuter C-150. Since these are the two most popular civilian training aircraft in the United States, the use of both provided a more representative indication of a national training program. On the other hand, the use of different aircraft further complicated the analysis.

2.6.2 Experiment Overview

The experimental program basically consisted of three elements:

1. An increment to the students' normal ground and/or flight training.
2. Written and flight evaluations of the students' performance before and after the training increment.
3. Analyses of the performance data to evaluate the training effectiveness.

Each subject was calibrated with a one-hour evaluation flight in which he was asked to demonstrate stalls and to fly the aircraft at minimum controllable airspeed without intentionally stalling. Following the first evaluation flight, the subjects were divided into four groups as follows:

Group 1 - Control Group

This group received no additional experimental instruction prior to the second evaluation flight.

Group 2 - Ground School Group

This group received ground school instruction on the subject of stalls and spins prior to the second evaluation flight.

Group 3 - Stall Avoidance Training Group/Incipient Spins

This group received ground school instruction and two hours of flight instruction on stall and spin avoidance, but no intentional spins.

Group 4 - Spin Training Group

This group was given the same instruction as Group 3, plus training in intentional spins.

Following their training, the students received a second one-hour evaluation flight similar in content to the first. A portable TV camera and video tape recorder were used to provide a record of the evaluation flights. A statistical evaluation of the performance of each student group was made to determine the relative effectiveness of the three levels of training.

SECTION 3
STALL AWARENESS TRAINING SYLLABUS INCREMENT

This section describes the ground and flight training increments that were developed. The ground training was given to three out of the four training groups. The spin avoidance flight training was given to Groups 3 and 4, and the spin training was applied only to Group 4.

3.1 GROUND TRAINING INCREMENT

The ground training increment for the Stall Awareness Training Study consisted of lectures, written handout notes, the FAA movie "Stalling for Safety," and two written quizzes. The ground school was given in two class sessions, each lasting approximately two hours, as shown below:

<u>First Class</u>	<u>Class Length</u>
Multiple Choice Written Quiz	0:30
Stall Awareness Lecture	1:00
Movie: "Stalling for Safety"	0:30
 <u>Second Class</u>	
Stall Awareness Lecture	1:00
Question/Answer Period	0:30
Multiple Choice Written Quiz	0:30

During the first class, all subjects were given Quiz No. 1; the students in Training Group 1 (control group) were then given Quiz No. 2, while the rest of the subjects attended the lecture and movie. Students in Groups 2, 3, and 4 were given a set of written notes to review in preparation for the second class. These class notes (Appendix A) contained a comprehensive discussion of stalls and spins, including accidents, training, aircraft certification, and aerodynamics. The two class lectures covered the same material as the handouts but in lesser detail (Table 2). At the end of the second class, Quiz No. 2 was administered to the subjects in Groups 2, 3 and 4. Appendix B contains the two written quizzes used in the ground training increment.

3.2 FLIGHT TRAINING INCREMENT DESCRIPTION

The flight training increment was administered during two flights of approximately one hour each. Students in Group 4 received about one-half hour more instruction

TABLE 2. OUTLINE FOR GROUND SCHOOL LECTURES.

1. INTRODUCTION

- a. ASI Introduction
- b. FAA Contract and Overview of the Stall Awareness Training Study

2. HISTORICAL AND REGULATORY ASPECTS

- a. History and Trends in the Percentage of Stall/Spin Accidents
- b. History of Civil Pilot Training and Certification Requirements in the Areas of Stalls and Spins
- c. Aircraft Certification Requirements
 - 1. Normal, Utility, Acrobatic
 - 2. Single and Multi-Engine
 - 3. Lack of Extensive Spin Testing on Aircraft Not Certified for Spins
 - 4. Aircraft Configuration During Spin Testing

3. CURRENT CIVIL PILOT TRAINING

- a. Angle of Attack Awareness. Flight at Minimum Controllable Airspeed
- b. Airplane Handling Characteristics at Minimum Operating Speed
- c. Stall Series

4. ACCIDENT STATISTICS - STALL/SPIN

- a. Critical Phases of Flight
 - 1. Takeoff and Initial Climb
 - 2. Approach to Landing
 - 3. Power Failure
 - 4. Go Arouns
 - 5. Unwarranted Low Flying
- b. Pilot Errors in Critical Phases of Flight. Distraction
- c. Stall Avoidance/Awareness, Recognition. Proper Flying Technique

5. AERODYNAMICS

- a. Airfoil Theory - Angle of Attack - Stalling - Control Responses at High Angle of Attack
- b. Stalling is Independent of Airspeed

TABLE 2. OUTLINE FOR GROUND SCHOOL LECTURES (CONTINUED).

<p>5. AERODYNAMICS (Continued)</p> <ul style="list-style-type: none">c. Forces and Moments in a Spind. Aerodynamic Function of the Controls in a Recoverye. Inability of Some Aircraft to Recover from a Spin Due to Ineffective Aerodynamic Controlsf. Structural Loads and Airspeed Limitations in a Spin Recoveryg. Effect of Airplane Configuration on Spin Recovery (Flaps, Gear, Power)h. Design of Non-Spinable and Spin Resistant Aircraft. Current NASA Research Programs on Spin Characteristics of Light Aircraft <p>6. DESCRIPTION OF STALLS</p> <ul style="list-style-type: none">a. Types of Stallsb. Stall Recoveryc. Scenarios for Stall Avoidanced. Spin Avoidance <p>7. DESCRIPTION OF A SPIN</p> <ul style="list-style-type: none">a. Motion and Attitudeb. Entry from a Stall - Control Positionsc. Recovery - Control Positions - Altitude Loss - Safe Altitudesd. Execution of Intentional Spins

than Group 3, during which spin training was given. The flight increment included training in the following areas:

- Scenarios leading to inadvertent stalls/spins.
- Stall avoidance practice.
- Spin avoidance practice (rudder effectiveness in delayed recovery stalls).
- Full spin training (Group 4 only).

Conventional stall entry and recovery are covered in the normal flight syllabus. The new increment added training not included in the usual program of flight instruction.

3.2.1 Scenarios

The emphasis of the flight training increment was placed on recognizing and avoiding inadvertent stalls which lead to serious accidents because of their occurrence close to the ground. To dramatize the flight instruction it included scenarios of typical flight situations where stall/spin accidents frequently occur. The main difference between the scenario and the real situation is that the former was conducted at a safe altitude. The scenarios used in the flight training increment included the following.

- Short Field Takeoff

This made the student aware of the hazards involved in a stall on takeoff which could occur simply because of poor pilot technique, or due to other factors (such as a short runway with obstructions, overloaded aircraft, wind shear, or high density altitude) which may cause a pilot to attempt a maximum angle climb. Pitch attitude after takeoff was continuously increased to clear obstacles, resulting in a departure stall. This scenario was conducted at altitude by slowing to liftoff speed, increasing the pitch attitude, and applying takeoff power, as is normally done in the practice of a departure stall. The demonstration is most effective if rudder coordination is improper when the aircraft stalls. It can be commenced from coordinated turns or straight flight and with the feet off the rudder pedals. The student was made familiar with the tendency of the airplane to enter a spin to the left from a departure stall, due to the left yawing moment generated at high angle of attack and high power. He was reminded that this uncompensated left yawing moment is likely to be largest in a climbing turn to the right, where right rudder pressure is required not only to compensate for the left yawing moment at high angle of attack/high power, but also to generate a net yawing moment in the direction of the right turn. In order to make a right turn in such a steep climb, many pilots use insufficient right rudder, and excessive right aileron. This produces a slipping turn to the right (ball indicator far to the right), with the result that if a departure stall occurs, the plane rapidly enters a spin to the left "over the top." The tendency of the airplane to enter a spin from a departure stall in a left turn was somewhat less pronounced, since with no rudder pressure applied by the pilot, the left yawing moment was approximately correct to result in a coordinated turn and the stall break did not result in such rapid development of a spin. In any case, the student realized that a departure stall is especially critical not only because of the altitude loss which may result in the stall, but also because of the tendency of the airplane to rapidly enter a spin to the left at a critically low altitude.

- Engine Failure on Takeoff or Initial Climb

This demonstration emphasized the need for immediate reduction of pitch attitude to avoid a stall if an engine failure occurs on takeoff or initial climb, and familiarized the student with the altitude loss and stall/spin hazard if a 180° turn back to the runway was attempted. For the demonstration, a climb was established at best angle of climb airspeed, and the altitude noted as power was reduced to idle. If pitch attitude was not immediately reduced, a stall or high rate of sink might develop. The rapid loss of airspeed when the simulated power failure occurred, and the altitude loss until best glide airspeed was attained straight ahead, were noted. After best glide speed was reached, a 180° descending turn was executed, noting the altitude upon completion of the turn. This impressed upon the student the minimum altitude required to turn back to a runway after power failure on initial climb. The student also was reminded that this test was made in a non-critical training environment at high altitude, but that it would be far more difficult to safely execute such a maneuver under actual emergency conditions near the ground, where terrain and obstructions increase the hazard. Under these conditions, the pilot would also be more likely to enter an inadvertent stall or spin due to distraction or while attempting to maneuver to avoid terrain or obstructions.

- Cross Controlled Turns to Final Approach

These two training exercises, conducted at a safe altitude, made the student aware of errors which could result in a stall or spin during a poorly planned and executed turn from base to final approach. The instructor also explained how these circumstances might arise during an emergency landing following a power failure, and emphasized the need for avoiding these errors, since the low altitude at which they would occur in actuality makes recovery from a spin difficult or impossible.

Skidding turn to final approach. This scenario simulated the airplane at too low an altitude on the turn from base to final approach. Due to the low altitude, the pilot would hesitate to use a properly banked turn, and instead attempted the turn using excessive (bottom) rudder to yaw the airplane onto final approach. The excessive rudder caused the plane to begin to bank and develop a nose down pitch attitude. At this point the pilot's attention was diverted entirely to ground references, he might not have been aware of his control movements, and so might have applied opposite aileron to prevent steepening the bank, and further nose up elevator to oppose the nose down pitching

tendency. These control movements and positions could result in a stall followed by a spin towards the inside of the turn. The similarity of the control positions in this improperly executed turn, to those required to initiate a spin, were pointed out to the student. The instructor emphasized the avoidance of these errors through proper planning in the traffic pattern, with correct airspeed, altitude and power control, and coordinated medium bank turns.

Slipping turn to final approach. In this scenario, the turn from base to final was started too late to avoid overshooting the simulated runway centerline. Consequently, the pilot would roll rapidly into a steep bank, with insufficient rudder pressure in the direction of the turn. The steep bank caused a nose down pitching tendency, and increased sink rate which the pilot attempted to oppose with aft elevator control movement, resulting in an accelerated stall, and a spin toward the outside of the turn. This demonstration served to clarify the common student misconception that a stalled airplane tends to spin toward the low wing, or inside of a turn. The control positions in the improperly executed slipping turn can cause a spin in the direction of the outside or high wing. The instructor emphasized the avoidance of these errors through proper planning in the traffic pattern, with correct airspeed, power and altitude control, and coordinated medium bank turns.

In both cross-controlled turn demonstrations, the instructor emphasized that errors of this type result in flight control positions which initiate a spin at a critically low altitude, making proper stall avoidance techniques vitally important. These errors are particularly likely to occur in the event of a powerplant failure and forced landing, where the pilot would be faced with a difficult situation, and might attempt to make a rapid turn at low altitude, while he tried to extend a glide by using excessive up elevator control.

- Overtaking Slower Traffic

This training scenario was used to demonstrate how a pilot's attention may be diverted from aircraft control to visual reference to another aircraft while attempting to fly at reduced airspeed, thus causing a stall or loss of control. In a simulated traffic pattern, a reduction of power and increase in pitch attitude were made in an effort to maintain spacing behind slower traffic. The pilot's attention was diverted to visual reference to the traffic ahead, and he might not notice instrument or other indications of a near-stall condition.

- Power Loss or Improper Airspeed Control on Final Approach

The instructor simulated a loss of power in the landing configuration at final approach airspeed and asked the student to prevent the aircraft from losing more than 100 feet of altitude during the next 20 seconds. This maneuver was similar to that which a pilot might attempt following a loss of power on final approach. The reaction to this situation would usually be an increase in up elevator deflection, which might cause a full or partial stall. The instructor related the student's control actions to those which might be used following a power loss on final approach.

- Recovery from a High Rate of Sink on Final Approach

The student established a power-off glide in the landing configuration at $1.1 V_{s0}$, and noted the vertical speed indication and altitude as recovery was begun by executing the recommended go-around procedure for the aircraft. The altitude loss until the rate of sink had been stopped was noted and discussed with the student. This scenario demonstrated what might occur if poor airspeed and power control are used during final approach, and could become critical if the pilot delays initiation of a go-around with minimum speeds. The measured altitude loss gave an indication of the minimum altitude loss necessary to arrest the rate of sink. The instructor pointed out the likelihood of a stall near the ground in the actual situation would be increased because the pilot might make a sudden application of up elevator to avoid an obstacle.

- Go-Around with Full Nose-Up Trim

This scenario showed how an improperly executed go-around could result in an inadvertent stall or spin, particularly if the pilot delayed initiation of the go-around until obstacle clearance at the departure end of the runway became a factor. The student established a properly trimmed descent to simulate a short field approach at the recommended speed, and initiated a go-around by application of full power. Insufficient forward elevator pressure to counteract the nose-up trim setting could result in an extreme nose-high pitch attitude and stall or spin, especially if the aircraft was loaded at aft c.g.

- Go-Around with Premature Flap Retraction

The purpose of this training exercise was to familiarize the student with the effect of retracting flaps at a speed below the flaps-up stalling speed, such as might

occur on a mishandled go-around. This was demonstrated by simulating a go-around from a descent at the short field approach speed. A landing flare was simulated to reduce the speed to just above the flaps-down stalling speed; then full power was applied, and the flaps were rapidly retracted, resulting in a full or partial stall.

- Left-Turning Tendency on a Go-Around in a Right Crosswind

For this demonstration the student set his flight controls in a position which aggravated the left turning tendency of the airplane during a go-around. A slipping approach to the right, such as used to compensate for a right crosswind on landing, was established with proper approach speed and trim. This required right aileron and left rudder to oppose the right yawing moment created by the vertical tail. A go-around was then simulated with application of full power and climb pitch attitude. If the pilot was slow in neutralizing the left rudder, a strong left yawing motion developed; this could result in rapid entry into a spin to the left if the nose-up elevator was incorrectly applied.

3.2.2 Flight at Minimum Controllable Airspeed/High Angle of Attack

This exercise was intended to serve as a review of the concept of angle of attack and the principles of aircraft control at minimum operating speeds. It was also designed to aid in the development of stall recognition by requiring the student to fly in a high angle of attack condition for an extended period of time. In the clean configuration, the student slowed the aircraft to the speed at which the visual or aural stall warning indicator was continually activated. Altitude was maintained by pitch attitude and power setting. Special emphasis was placed on correct torque compensation to maintain heading and coordinated flight. After equilibrium flight was established, the rudder was released to demonstrate the strong left turning tendency in this high angle of attack/high power condition. Climbs, descents and turns were made in this condition. Turns were made with 15° angle of bank and an increase in power as necessary to maintain altitude. Proper coordination of the turns and the difference in rudder pressure required for right and left turns were noted. Turns were also made at 30° angle of bank with the stall warning indicator continually activated. The student was shown that in this condition, altitude can be maintained in the turn only through an increase in power to increase the airspeed. No change of elevator position is necessary, and the stall warning indicator will remain activated, even though the indicated airspeed

is slightly greater than in straight flight. This showed the student that indicated airspeed at the onset of a stall is a function of the maneuvering acceleration (or bank angle) in a coordinated turn. As a further demonstration, the student was asked to attempt to maintain altitude in a 30° banked turn, using increased up elevator with no increase in power. The result was, of course, an accelerated stall. Straight flight at minimum controllable airspeed was also practiced with progressive extension of full flaps and power as required to maintain altitude, with the stall warning indicator continually activated. The effects of flap extension and power settings on the elevator control forces was noted, as well as the right rudder pressure required to maintain heading in coordinated flight. Full power was applied and the available rate of climb was determined.

3.2.3 Incipient Spins, Spin Avoidance, and Spin Training

Group 3 students received instruction in incipient spins/spin avoidance. For the incipient spin, the student executed a power-off stall and applied rudder to initiate a spin just as the stall occurred. As the airplane began to drop a wing and enter the spin, opposite rudder and forward elevator were applied for recovery. This exercise familiarized the student with control usage to enter and recover from a spin and demonstrated the effect of the rudder in a stall.

Group 3 students also practiced oscillation stalls. The airplane was stalled with the engine throttled to idle; full back elevator was held with ailerons neutral and rudder control was used to prevent dropping a wing or a spin. The student attempted to hold the airplane in the stall until two or three pitch oscillations occurred.

Group 4 students received the same instruction as those in Group 3, plus about one-half hour of intentional spins. Intentional left and right spins of up to two turns were made from coordinated flight. The instructor emphasized the control positions necessary to cause the aircraft to enter a spin: the elevator is deflected full up to stall the aircraft, followed by full rudder deflection in the desired direction of the spin to induce a yawing moment. The intent of this emphasis on the control positions which induce a spin was to develop the student's understanding of how an inadvertent spin may be entered, especially in those phases of flight that involve operation below cruise airspeeds and at high angle of attack.

3.3 FLIGHT TRAINING INCREMENT SYLLABUS

This subsection presents the flight training syllabus increment that was developed for the Stall Awareness Training Study and given to each participating flight instructor.

3.3.1 Preflight

In addition to the normal preflight inspection and discussion, instructors should review specific points regarding aircraft preflight for spin training, and weight and balance limitations appropriate to the aircraft when used for spins.

3.3.2 First Flight Lesson

[Note: Minimum Altitude 5000 ft AGL]

1. Stall Avoidance Practice at Minimum Controllable Airspeed (0:25)*
 - a. Assign heading and altitude, reduce power, slow to minimum controllable airspeed.
 - b. Trim. Maintain heading and altitude with stall warning light on. Demonstrate the effect of elevator trim (use neutral and full nose-up settings) and rudder trim.
 - c. Point out left turning tendency. Emphasize effectiveness of rudder for lateral/directional control. Emphasize right rudder pressure necessary to center ball indicator and maintain heading. Release rudder and show student the left yaw.
 - d. Turns, climbs, descents at minimum controllable airspeed. Flap extension and retraction are practiced in level flight, climbs and descents. Emphasize proper flap retraction procedure to avoid a stall at low airspeed. Point out airspeed indications and emphasize their relation to V_{S0} and V_{S1} .
 - e. Make right and left climbing turns at minimum controllable airspeed with feet off the rudder pedals. Explain indications of the ball indicator in the right and left turns.
 - f. Adverse yaw demonstration. Have the student enter left and right turns at minimum controllable airspeed with feet off the rudder pedals. Note adverse yaw.
 - g. Distractions at minimum controllable airspeed. Give student a task to do while flying at minimum controllable airspeed. Reading a chart, working a computer problem or a turn about a point on the ground can be used to distract his attention from flying the airplane. Try to teach him to divide his attention between the tasks so that he retains good control of the airplane and does not stall.
 - h. Flight at minimum controllable airspeed with airspeed indicator covered. Use various flap settings. Give student distractions.

* Approximate time required for each phase of the lesson is shown in parentheses.

2. Stall After Takeoff (0:10)

- a. Have the student attempt coordinated departure stalls straight ahead and in turns. Emphasize to him how these could occur on takeoff.
- b. Repeat the departure stalls with feet off the rudder pedals to demonstrate the effect of poor coordination straight ahead and in turns. Emphasize the tendency to spin if coordination is improper.
- c. Ask the student to demonstrate a departure stall and distract him just before the stall. Explain any effects the distraction may have had on the stall or recovery.

3. Engine Failure in a Climb Followed by 180° Turn (0:05)

The purpose of this demonstration is for the student to learn how much altitude his aircraft loses following a power failure on takeoff and during a 180° turn back to the runway. Set up a climb at V_Y . Reduce power smoothly to idle as the aircraft passes through a cardinal altitude. Lower the nose to maintain best glide speed and make a 180° turn at best glide speed. Point out altitude loss and emphasize how rapidly air-speed decreases following a power failure in climb attitude. This can be tried using medium and steep banks in the 180° turn but especially emphasizing stall avoidance.

3.3.3 Second Flight Lesson

[Note: All Stall and Spin Recoveries to be completed above 4000 ft AGL]

1. Cross-Controlled Stalls in Gliding Turns (0:05)

Do stalls in gliding turns to simulate turns from base to final. Fly the stalls from a properly coordinated turn, a slipping turn and a skidding turn. Explain the difference between slipping and skidding turns, explain the ball indicator position in each turn and the aircraft behavior in each of the stalls.

2. Approach-to-Landing Stalls and Go-Arounds (0:10)

Begin with a full-flap, approach-to-landing stall with correct recovery and cleanup procedure. Note altitude loss. Repeat this while distracting the student during the stall and recovery to see what effect distraction has. Then show how errors in the flap retraction procedure can cause a secondary stall.

- a. Stall in full-flap configuration. Recover and attempt a climb with flaps. If normal climb attitude is held, a secondary stall will occur.

- b. Stall in full-flap configuration. Recover, add power and retract the flaps quickly as the nose is raised to level or climb attitude. A secondary stall or settling and loss of altitude will result. Emphasize how critical these errors are in a stall at low altitude or during a go-around.
- c. Place the airplane in approach configuration in a trimmed descent. After the descent is stabilized, begin a go-around procedure by adding full power but use only light forward elevator pressure and allow the trim to cause the nose to pitch up into an imminent stall. Emphasize the need for correct attitude control and over-powering of wheel forces on a go-around. This stall can be abrupt especially if rudder control is poor.

3. Oscillation Stalls (0:05)

Fully stall the airplane and maintain full nose up elevator control to hold it in the stall. Teach use of rudders to prevent dropping a wing or a spin. Note the airplane pitching and yawing motions in the delayed stall, and the rate of descent. Use idle power.

4. Incipient Spins (0:20)

Stall the airplane and apply control to enter an intentional spin. Release the pro-spin controls and recover as the spin begins. Discuss control application, recovery and repeat the maneuver until the student recognizes the entry and can perform the recovery. The falling-leaf maneuver is also practiced. Full rudder is applied with the airplane in a stalled condition. As it begins to fall off on a wing, the rudder is reversed until it falls off on the other wing.

5. Full Spins (Group 4 Students Only) (0:25)

Discuss the execution of an intentional spin and recovery. Demonstrate a 2-turn spin and allow the student to practice spins in each direction.

SECTION 4 FLIGHT EVALUATION

This section describes the evaluation flight program and scoring procedures that were used to investigate the effectiveness of the stall awareness training increment. As previously discussed, the evaluation flight was given to each subject twice - before and after he received the incremental training (if any).

4.1 FLIGHT DESCRIPTION

The evaluation flights were administered by an ASI pilot or (in a few cases) by a senior member of the flight school staff. Each flight consisted of two parts. The first part tested the student's ability to demonstrate intentional stalls and recovery techniques; the second tested the student's ability to avoid unintentional stalls when distracted during flight at minimum controllable airspeed. During the first part, five factors were taken into consideration in the evaluation of the subject's intentional stall performance:

1. Sensing and recognition of the stall.
2. Pitch attitude control during recovery.
3. Coordinated use of ailerons and rudder for lateral/directional control during recovery.
4. Minimum altitude loss consistent with good recovery technique. Application of power only after effective control is regained.
5. Correct flap retraction procedure and cleanup.

During the second part of the evaluation flight, the student pilot's objective was to maintain desired heading and altitude at an airspeed and angle of attack which activated the stall warning device, but which did not cause the aircraft to stall. While in the high angle of attack region, the student was asked to conduct maneuvers that might cause inadvertent stalls. He was also given typical piloting side tasks that are known to be distracting from the primary task of controlling the aircraft; examples of these distractions are given in Table 3. The grading of this part included the number of unintentional stalls, the number of unintentional spin entries, and the number of evaluator takeovers, as well as the aircraft configuration and maneuver at the time of an inadvertent stall. For the purpose of scoring this part, a stall was defined as any significant change

TABLE 3. EXAMPLES OF DISTRACTION SCENARIOS.

1. Drop pencil - ask subject to pick it up.
2. Ask subject to determine heading to an airport using chart.
3. Ask subject to reset clock to Greenwich time.
4. Ask subject to get something out of the glove compartment.
5. Ask subject to count number of corrugations on aileron, flap or horizontal stabilizer.
6. Ask subject to get something from rear seat.
7. Ask subject to read the outside air temperature.
8. Ask subject to call FSS for weather information.
9. Ask subject to compute TAS or density altitude with E6B.

in pitch attitude, roll attitude, or altitude rate; a spin was defined as a stall followed by a change in bank angle of 60° or a change in heading greater than 30° . An evaluation pilot takeover assumed for scoring purposes that a spin occurred. The evaluation also determined an overall subjective grade, on a scale of -3 to +3, of the subject pilot's ability to recognize and avoid inadvertent stalls. The total time in the stall warning range and the number of times out of the stall warning range for more than 5 seconds were recorded (unless the reason for being out of the stall warning range was associated with a stall recovery).

At various times during both parts of the flight, the evaluation pilot could close the throttle to simulate loss of power due to fuel mismanagement or carburetor ice. The student was briefed prior to the flight that when this occurred, he should avoid a stall by reducing pitch attitude to a normal glide, add carburetor heat and switch tanks or check fuel selector as appropriate, at which time control of the throttle would be returned to him. The subject's ability to avoid a stall was evaluated on the scale of -3 to +3 after each simulated engine failure. The evaluation pilot did not manipulate the controls except to simulate loss of power or to take over because the aircraft was approaching an unsafe condition.

4.2 INSTRUCTIONS TO THE SUBJECT PILOT

"This flight will be divided into two parts. During the first part you will be asked to demonstrate five intentional stalls. They will be:

- Power-off stall, straight ahead.
- Stall in a 30° banked right turn.
- Stall with full flaps.
- Power-off stall - recovery without power to a normal glide.
- Departure stall in a right turn.

"You should recover from the stalls promptly after you sense the 'stall break' or when you reach full elevator deflection with no further stall development. We will be evaluating:

- Sensing and recognition of the stall.
- Pitch attitude control during recovery.
- Coordination of rudder and ailerons.
- Your ability to minimize altitude loss consistent with good recovery technique. You should add power only after effective control is regained.
- Flap retraction and cleanup procedure.

"During the second part of the flight, you will be asked to fly at minimum controllable airspeed (high angle of attack).

- Fly the airplane at a speed which continually activates the stall warning indicator, but avoid stalling the airplane.
- Maintain heading and altitude.
- While in the low airspeed/high angle of attack range, you will be requested to conduct maneuvers which may cause inadvertent stalls. This also will include distractions or side tasks such as chart reading to divert your attention from the primary task of flying the airplane.
- If you unintentionally stall the airplane, recover to straight and level flight at cruise airspeed, and the evaluator will tell you when to resume flight in the stall warning range.
- The evaluation pilot will not manipulate the controls except to take over if the aircraft approaches an unsafe condition.
- Several times during the flight, the evaluation pilot will reduce the power to idle and say 'Loss of Power.' You should promptly lower the nose to a normal glide, apply carburetor heat, and check the fuel selector. After you have done these three things, he will return control of the throttle to you.

"Your performance will be judged on:

- Your ability to maintain airspeed and angle of attack in the desired range (i.e., keep the stall warning indicator on without stalling the airplane).
- The number of inadvertent stalls you experience.
- The length and number of times the stall warner deactivates because your airspeed is too fast (angle of attack is too low).
- Your ability to avoid a stall when the loss of power is simulated."

4.3 DETAILED EVALUATION FLIGHT PLAN

	<u>Time</u>
1. Engine start, taxi, runup, takeoff checklist.	0:08
2. Takeoff and climb to 5,000 ft MSL altitude:	0:08
● Power failure will be simulated during the climb (at 3,000 ft).	
3. Evaluation of intentional stall recovery:	
Upon reaching altitude and practice area, five intentional stalls will be demonstrated, with clearing turns prior to each stall.	
● Power-off stall, straight ahead.	0:02
● Accelerated stall in 30° bank right turn.	0:02
● Approach to landing stall, full flaps in left turn.	0:02
● Power-off stall, recovery to a normal glide without use of power.	0:02
● Departure stall in a right turn.	0:02
	<hr/> 0:10
4. Evaluation of Unintentional Stall Avoidance:	
The student will be asked to establish flight at minimum controllable airspeed in the clean configuration with the stall warning indicator activated. A cardinal heading will be used at 5,000 ft MSL.	0:08

● After three (3) minutes the student will be asked to refer to a Sectional Chart to determine the control tower frequency at a designated airport.	
● A power failure will be simulated in straight flight.	
● Demonstrate 30° banked turns through heading changes of 360° left and right in level flight climbs and descents. The student will be distracted by questions about ground objects and asked to pick up an object from the floor. A power failure will be simulated in a turn.	0:10
● While flying in the stall warning range, the student will be asked to extend flaps, maintaining a cardinal heading and 5,000 ft MSL altitude. He will be distracted by being asked to read a placard in the aircraft, or to describe an object on the ground.	0:06
5. Descent, pattern entry and landing.	0:10
	<hr/>
Total	1:00

4.4 EVALUATION FLIGHT SCORING

The scoring of the subject's performance was accomplished by the use of a videotape recording made during each evaluation flight. A portable video camera was mounted between and aft of the two pilots to record the instrument panel readouts during the evaluation flight. The evaluation pilot also wore a headset microphone which enabled him to make oral observations throughout the flight. This procedure provided an accurate audio-video record of the flight for later review and grading on the ground. Besides allowing a more objective scoring of the flight, removed from the excitement of the cockpit, the videotape recorder contributed to safety by eliminating distractions to the evaluation pilot, since he was not required to take written or mental notes.

The video tapes were reviewed and graded by the evaluator using the scoring form shown in Figure 2. All subjective grades were scored on a scale from -3 to +3, which was chosen so the evaluator's grade could be considered in terms of a normal distribution with zero mean and unity standard deviation. Each unintentional stall during the flight was counted in the table in Figure 2, and all pertinent descriptors were checked. The evaluator was asked to provide an overall subjective grade of the

subject's stall avoidance capability on that flight and, for the second evaluation, an overall assessment of the subject's improvement.

In addition to the data recorded on the scoring form, the evaluator noted other information for the subsequent statistical analysis, including:

- Subject's age
- Subject's flight instructor
- Airmen certificates held
- Aircraft type
- Training group
- Total flight time prior to the evaluation flight
- Flight time during preceding two months
- Flight time during preceding 10 days
- Total number of stalls practiced prior to the evaluation flight
- Total number of spins practiced prior to the evaluation flight

The flight time during the last 10 days and the last two months was used to estimate the student's recency as defined by:

$$\text{Recency (hrs)} = \frac{\text{Total time in last 10 days (hrs)} + \text{Total time in last two months (hrs)}}{10}$$

In Reference 2 recency and the logarithm of total time were found to be the best indicators of skill variation among non-instrument rated civil pilots.

Evaluator

Student

EVALUATION FLIGHT SCORING FORM

I. Intentional Stall Performance (-3 to +3)

- 1. Sensing and recognition of the stall. _____
- 2. Pitch attitude control during recovery. _____
- 3. Coordinated use of ailerons and rudder for lateral/directional control during recovery. _____
- 4. Minimum altitude loss consistent with good recovery technique. _____
- 5. Correct flap retraction procedure and cleanup. _____

II. Unintentional Stall Performance

Stall Descriptors	Stall No.															Total
	1	2	3	4	5	6	7	8	9	10	11	12	13	14	15	
Distracted inside/outside																
During simulated engine loss																
Flaps up																
Flaps 1/2 - 2/3																
Flaps down																
Out of trim																
During intentional stalls																
Climbing																
Descending																
Turning right/left																
With ball indicator out																
Secondary stall																
Unintentional spin																
Takeover																

FIGURE 2. EVALUATION FLIGHT SCORING FORM.

III. Stall Performance After Simulated Engine Failure (-3 to +3)

First try _____

Second try _____

Third try _____

IV. Slow Flight Performance

Total time in slow flight (min) _____

Times out of stall warning range
(if > 5 seconds and not a stall
recovery) _____

V. Evaluator's Subjective Scores (-3 to +3)

Rudder (Ball Indicator) Control _____

Altitude Control _____

Heading Control _____

Subject's Overall Stall
Avoidance Capability _____

Subject's Improvement in
Stall Avoidance Relative to
First Evaluation Flight

[Second Evaluation Flight Only] _____

FIGURE 2. EVALUATION FLIGHT SCORING FORM (CONTINUED).

SECTION 5 DATA ANALYSIS

This section describes the procedures applied to record, process and analyze the data obtained in the Stall Awareness Training Study. The information was computerized, then processed by several standard statistical analysis routines. Because of the volume of the outputs, only typical or especially noteworthy results are presented here. The next section of the report discusses the major conclusions and observations obtained through careful evaluation and interpretation of the statistical results.

5.1 DATA SCORING AND RECORDING

As described previously, the Stall Awareness Training Study was administered in parallel to students at two flight training schools beginning in the fall of 1975. The original goal was to obtain a sample of at least 100 student pilots to volunteer for the experimental evaluation, using four hours of free flying time as a major incentive. However, because of an insufficient number of beginning student pilot volunteers, the program was extended to all pilots training at these flight schools (including a few who were not enrolled in the regular academic curriculum). The number of subject pilots who eventually completed the various phases of the Stall Awareness Program is summarized in Table 4.

TABLE 4. STALL AWARENESS PROGRAM PARTICIPATION SUMMARY.

Program Phase	Training Group				Total
	1	2	3	4	
Evaluation Flight No. 1	11	11	18	22	62
Quiz No. 1	10	10	17	20	57
Ground School	-	10	17	21	48
Quiz No. 2	9	10	17	20	56
Flight Instruction	-	-	14	20	34
Evaluation Flight No. 2	10	9	14	18	51

The first step in the experimental program was to conduct the first evaluation flight for each subject pilot, using the video tape recorder (VTR) to record the instrument panel and evaluator's comments for subsequent scoring. Next, the written quizzes and the appropriate ground and/or flight training increments were administered to the students, after which the second evaluation flight was conducted. Each evaluation flight was scored from the video tape recordings using the grading form shown in Figure 2. This information was combined with the quiz grades and other pertinent data to form the data base for analysis. Next, this was recorded on a computer input data form, shown in Figure 3*, from which the data were entered into the computer disk file. Appendix C contains a complete record of the raw data used for the statistical analyses in the same format as Figure 3. All missing data items were coded by -99.

The raw input data were processed by computer to form the primary data base for the analysis. Data from the two quizzes and evaluation flights were differenced to show the subject's change in performance. Also, two additional variables were calculated for each evaluation flight:

1.
$$\frac{\text{Total time out of stall warning range}}{\text{Total time in slow flight}}$$
2.
$$\frac{\text{Number of times out of stall warning range}}{\text{Total time in slow flight}}$$

The result was a data set containing 107 variables for each subject, which are summarized in Table 5. A data screening program was used to detect and tabulate missing or incomplete data.

5.2 BASIC STATISTICAL PROCESSING

The data were processed by a preliminary analysis program which generates histograms and summary statistics. The latter results, which are reproduced in Appendix D, present the number of valid observations, minimum value, maximum value, mean and standard deviation of the variables in Table 5. This information is given first for the entire subject population, followed by the corresponding data for each training group. The summary statistics are very useful to further verify the input data (e.g., by number of entries or range of a variable) and can also provide interesting observations

*Items 16 and 30 are the totals from Section II in Figure 2 (page 35).

STALL AWARENESS INPUT DATA

A. SUBJECT INFORMATION

1. Name (last, first initial): Nonamous, A.
2. Age: 21
3. Pilot License (N, P, C, A): P
(N = No license; P = Private; C = Commercial; A = ATR or other)
4. Flight Instructor (two initials): WH
5. Aircraft Type (P, C): P
(P = Piper; C = Cessna)
6. Training Group (1, 2, 3, 4): 2

B. GROUND INSTRUCTION QUIZ GRADES

7. Quiz No. 1: 13
8. Quiz No. 2: 13

C. FLIGHT EVALUATION NO. 1 (Refers to Flight Evaluation Grading Form)

9. Date (month/day): 12/05
10. Evaluation Pilot (two initials): MG
11. Total Time (hours): 117
12. Recency (hours): 3.02
13. Total Stalls: 200
14. Total Spins: 1
15. Intentional Stall Performance: 1 , 1 , 1 , 1 , 1
16. Unintentional Stall Performance: 0 , 0 , 1 , 1 , 4 ,
0 , 0 , 2 , 1 , 4 , 0 , 0 , 0 , 0
17. Simulated Engine Failure Performance (average): 0
18. Total Time in Slow Flight (minutes): 25.3

FIGURE 3. SAMPLE COMPUTER INPUT DATA FORM.

19. Total Time Out of Stall Range (minutes): 0.2
20. No. of Times Out of Stall Range: 1
21. Slow Flight Coordination Scores: 2.0, 1.5, 1.5
22. Evaluator's Overall Grade: 2
- D. FLIGHT EVALUATION NO. 2 (Refers to Flight Evaluation Grading Form)
23. Date (month/day): 03/12
24. Evaluation Pilot (two initials): MG
25. Total Time (hours): 199
26. Recency (hours): 1.2
27. Total Stalls: 150
28. Total Spins: 1
29. Intentional Stall Performance: 1, 1, 1, 1, 1
30. Unintentional Stall Performance: 3, 0, 1, 2, 2,
0, 0, 0, 0, 3, 0, 1, 0, 0
31. Simulated Engine Failure Performance (average): -99
32. Total Time in Slow Flight (minutes): 20
33. Total Time Out of Stall Range (minutes): 0
34. No. of Times Out of Stall Range: 0
35. Slow Flight Coordination Scores: 2, 1, 1
36. Evaluator's Overall Grade: 2
37. Evaluator's Improvement Grade: 0

FIGURE 3. SAMPLE COMPUTER INPUT DATA FORM (CONTINUED).

TABLE 5. DEFINITION OF STATISTICAL ANALYSIS VARIABLES.

<u>Variable No.</u>	<u>Description</u>	<u>Variable No.</u>	<u>Description</u>	
1	Subject Number	31	Turning	} Unint. Stall Per. #1 (Cont.)
2	Pilot License	32	Ball Out	
3	Aircraft Type	33	Secondary	
4	Flight Instructor	34	Spin	
5	Training Group	35	Takeover	
6	Age	36	Simulated Engine Failure #1	
7	Evaluation Pilot #1	37	Total Time In	} Slow Flight #1 Performance #1
8	Total Time #1	38	Time Out	
9	Recency #1	39	Time Out/Time In	
10	Total Stalls #1	40	No. of Times Out	
11	Total Spins #1	41	No. Times Out/Time In	
12	Evaluation Pilot #2	42	Rudder	
13	Total Time #2	43	Altitude	
14	Recency #2	44	Heading	
15	Total Stalls #2	45	Overall Subjective Grade #1	
16	Total Spins #2	46	Recognition	
17	Recognition	47	Pitch	
18	Pitch	48	Coordination	
19	Coordination	49	Altitude Loss	
20	Altitude Loss	50	Flaps	
21	Flaps	51	Distracted	} Unintentional Stall Performance #2
22	Distracted	52	Engine Loss	
23	Engine Loss	53	Flaps Up	
24	Flaps Up	54	Flaps 1/2-1/3	
25	Flaps 1/2-1/3	55	Flaps Down	
26	Flaps Down	56	Out of Trim	
27	Out of Trim	57	Intentional Stall	
28	Intentional Stall	58	Climbing	
29	Climbing	59	Descending	
30	Descending	60	Turning	

TABLE 5. DEFINITION OF STATISTICAL ANALYSIS VARIABLES (CONTINUED).

Variable No.	Description	Variable No.	Description
61	Ball Out	92	Turning
62	Secondary	93	Ball Out
63	Spin	94	Secondary
64	Takeover	95	Spin
65	Simulated Engine Failure #2	96	Takeover
66	Total Time	97	Change in Simulated Engine Failure
67	Time Out	98	Total Time In
68	Time Out/Time In	99	Time Out
69	No. Times Out	100	Time Out/Time In
70	No. Times Out/Time In	101	No. Times Out
71	Rudder	102	No. Times Out/Time In
72	Altitude	103	Rudder
73	Heading	104	Altitude
74	Overall Subjective Grade #2	105	Heading
75	Quiz #1 Grade	106	Change in Overall Subjective Grade
76	Quiz #2 Grade	107	Change in Quiz Grade
77	Subjective Improv. Grade		
78	Recognition		
79	Pitch		
80	Coordination		
81	Altitude Loss		
82	Flaps		
83	Distracted		
84	Engine Loss		
85	Flaps Up		
86	Flaps 1/2-1/3		
87	Flaps Down		
88	Out of Trim		
89	Intentional Stall		
90	Climbing		
91	Descending		

on the results of the experiment. For example, referring to the difference in written quiz scores (Variable No. 107), one can see that the mean score of the entire population (Group 0) increased by 1.164; the Control Group (Group 1) actually decreased by 0.6667, indicating that the second quiz was more difficult than the first. On the other hand, those who received the ground school instruction (Groups 2, 3, 4) improved by 1.300, 1.750, and 1.450, respectively.

The histograms were also useful to check the data for outliers and to provide an approximate indication of the probability distribution function of the data since several standard statistical analysis procedures are based on the assumption of normal distributions. Figures 4 and 5 present examples of the histograms for Variables 45 and 74, which are the overall subjective grades for the two evaluation flights. Considering the small sample size and the fact that these scores were assigned discretely from -3 to +3, the histograms indicate that a normal distribution assumption for these variables is not unreasonable.

Contingency tables were used to obtain a preliminary test of the independence of training group upon the change in subject performance from the first to the second evaluation flight or quiz. However, there was an insufficient number of subjects in each category to obtain statistical validity from these tests.

5.3 ANALYSIS OF VARIANCE

The analysis of variance (anova) is a powerful statistical tool for detecting differences among the means of several populations. It can also be used to analyze data from an experiment involving several sources of variation, to partition the total variation into components, and to estimate and test the significance of their effects.

Single classification (or one-way) anova was used to check for disparity among the four training groups prior to their receiving any additional training. Table 6 presents several results of the one-way anova to the subjects' ages, experience levels, first written quiz grades, and some performance observations from the first evaluation flight. The test statistic F , called the F ratio, is a measure of how well the data fit the hypothesis of equal means for the training groups; large values of F indicate the hypothesis should be rejected, i.e., the groups are statistically different. The hypothesis and residual degrees of freedom, ν_H and ν_R , are used with the value of F to determine the probability (P) that the groups differ from standard tables of the F distribution (e.g., References 4 and 5).

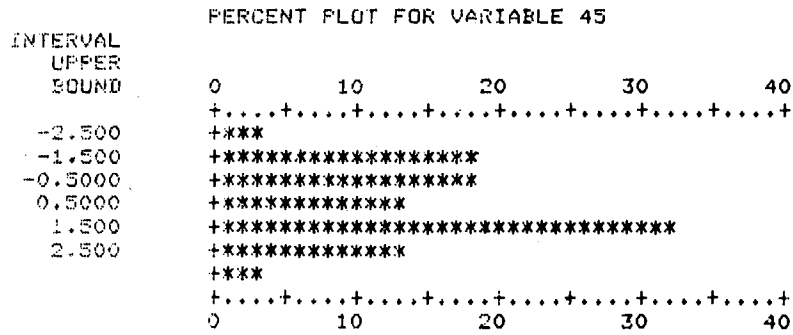

N = 62 MEAN -0.6452E-01 STD. DEV. 1.505
 MIN -3.000 MAX 2.500

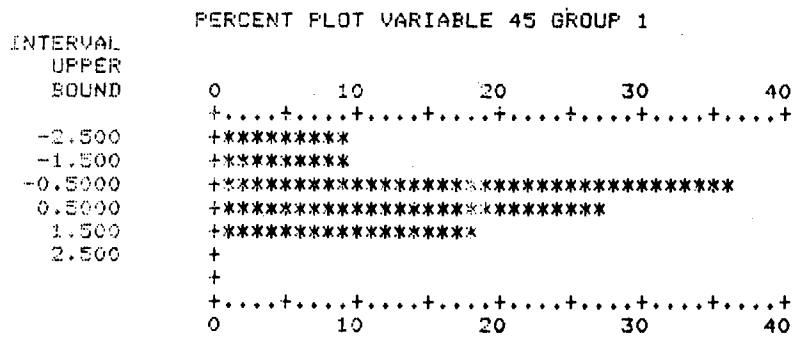

GP = 1 MEAN -0.7727 STD. DEV. 1.148
 MIN -3.000 MAX 1.000

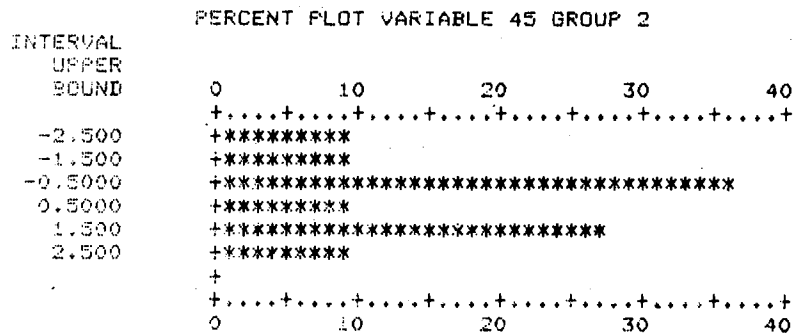

GP = 2 MEAN -0.4545 STD. DEV. 1.524
 MIN -3.000 MAX 2.000

FIGURE 4. HISTOGRAMS OF SUBJECTIVE OVERALL GRADES FOR FIRST EVALUATION FLIGHT (VARIABLE NO. 45).

PERCENT PLOT VARIABLE 45 GROUP 3

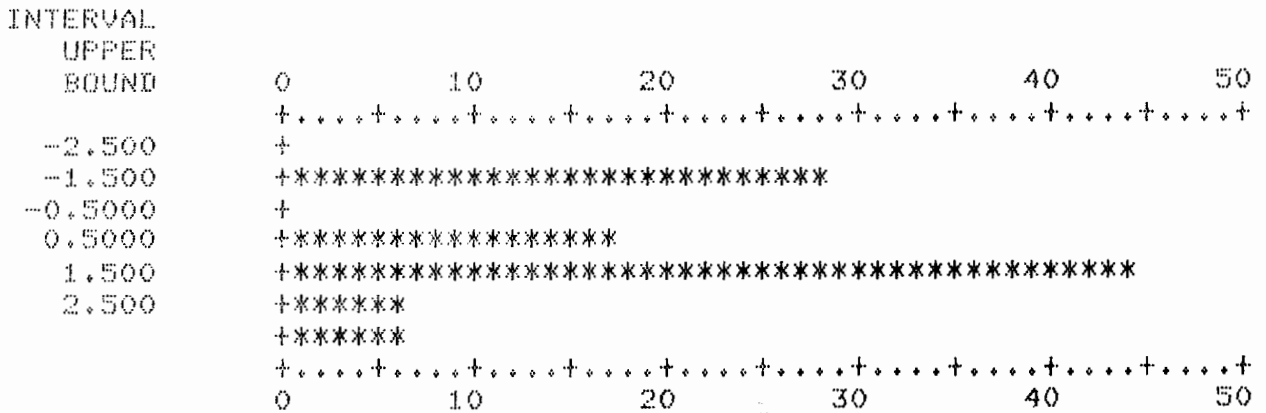

GP = 3 MEAN 0.5556E-01 STD. DEV. 1.514
MIN -2.500 MAX 2.500

PERCENT PLOT VARIABLE 45 GROUP 4

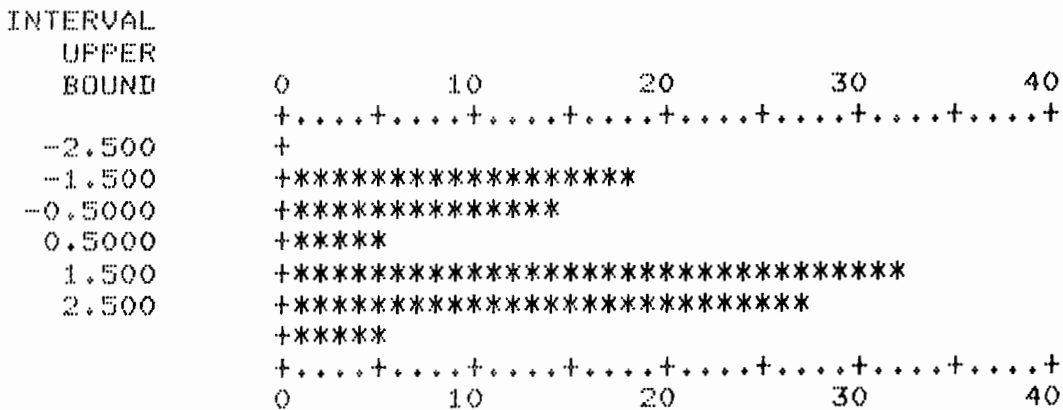

GP = 4 MEAN 0.3864 STD. DEV. 1.558
MIN -2.500 MAX 2.500

FIGURE 4. HISTOGRAMS OF SUBJECTIVE OVERALL GRADES FOR FIRST EVALUATION FLIGHT (VARIABLE NO. 45) (CONTINUED).

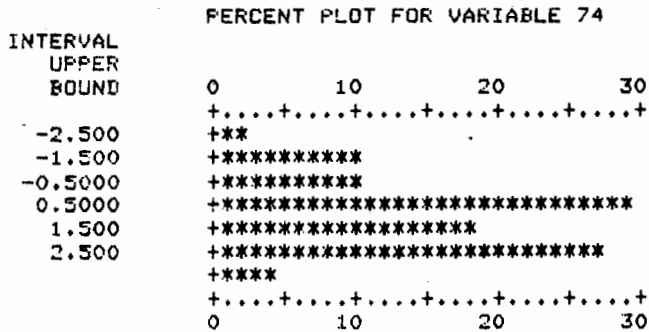

N = 51 MEAN 0.4118 STD. DEV. 1.410
 MIN -3.000 MAX 2.500

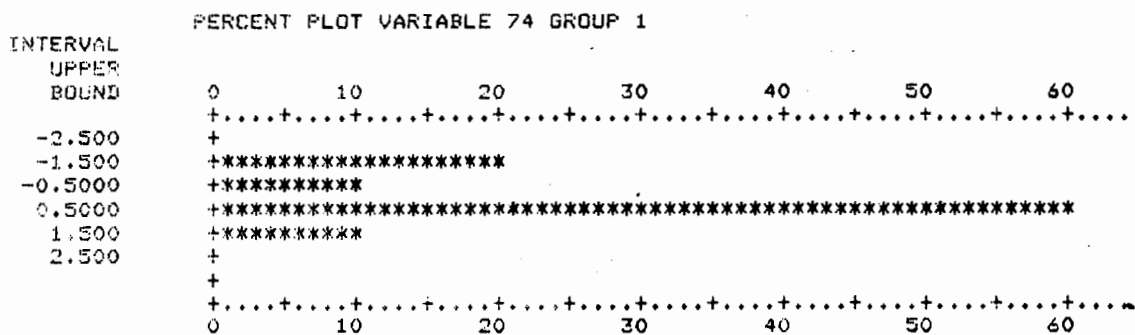

GP = 1 MEAN -0.4500 STD. DEV. 0.9560
 MIN -2.000 MAX 1.000

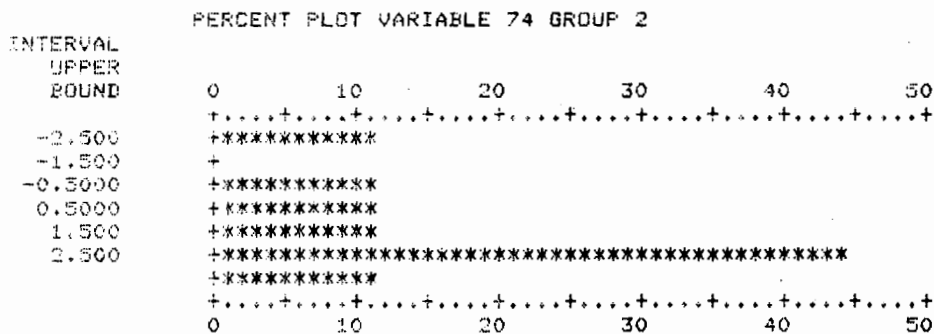

GP = 2 MEAN -0.5667 STD. DEV. 1.871
 MIN -3.000 MAX 2.500

FIGURE 5. HISTOGRAMS OF SUBJECTIVE OVERALL GRADES FOR SECOND EVALUATION FLIGHT (VARIABLE NO. 74).

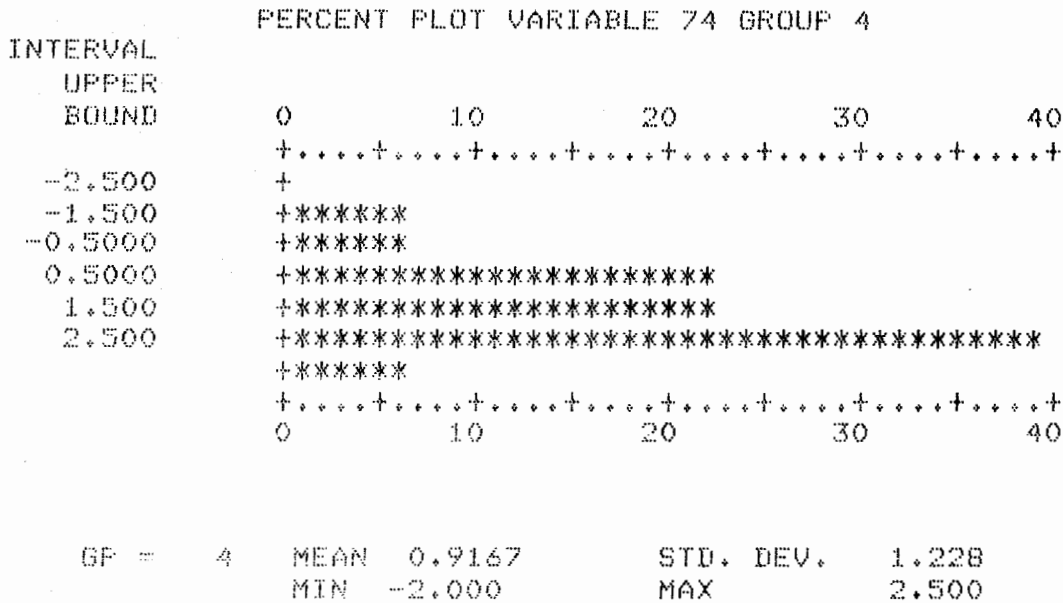
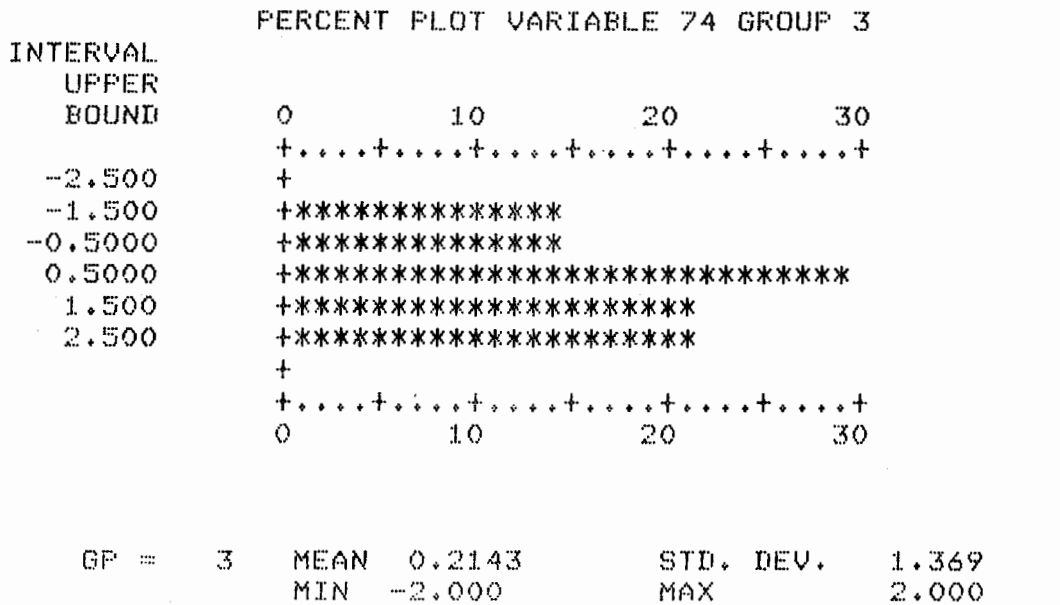

FIGURE 5. HISTOGRAMS OF SUBJECTIVE OVERALL GRADES FOR SECOND EVALUATION FLIGHT (VARIABLE NO. 74) (CONTINUED).

TABLE 6. ONE-WAY ANOVA OF SELECTED VARIABLES PRIOR TO TRAINING INCREMENT.

Variable	Mean Values					F	DOF ν_H, ν_R	P (%)
	Group 1	Group 2	Group 3	Group 4	All			
Age (yrs)	21.2	24.4	19.9	23.7	22.2	1.64	3,54	81
Flight Experience (hrs)	17.9	50.8	52.6	70.5	52.5	2.75	3,58	95
Quiz No. 1 Score	8.6	10.4	11.6	11.6	10.8	3.29	3,53	97
Unintentional Stalls	10.1	9.7	6.5	6.6	7.7	1.01	3,58	61
Unintentional Spins	0.20	0.18	0.33	0.41	0.31	3.49	3,58	98
Takeovers	0.10	0.36	0.22	0.23	0.23	0.72	3,58	
Subjective Grade	-.77	-.45	.06	.39	-.06	1.82	3,58	85

DOF = Degrees of freedom.

Table 6 shows, for example, that there is indeed a significant difference (at the 95 percent level) in the flight experience of the subjects assigned to the four training groups. This is partially explained by the decision to place all subjects with previous spin experience into Group 4, since these are the pilots who generally have logged more flight time. (With this exception, the remaining subjects were assigned to one of the four training groups on a random basis.) The significantly poorer performance on the first quiz by the Group 1 students is apparently due to their lower level of experience. There is no significant difference among the groups in terms of unintentional stalls on the first evaluation; although not statistically significant (85 percent), the difference in overall subjective grades is probably the result of the flight experience disparities. The inexplicable difference in unintentional spins is surprising since the more experienced Group 4 had the poorest mean performance in this area.

The analysis of variance can be used to test the differences due to two or more factors, such as training groups and type of aircraft. It can also be extended to include the effects of additional observed variables (covariates) such as total flight time. The BMD10V program (Reference 6) is one of the available statistical computer package routines which can be used to analyze this general model. In addition, it

enables the analyst to evaluate several hypotheses at the same time, and also generates least-squares regression equations for the observations.

This program was used to analyze several of the experimental results. The change in written quiz grades was evaluated to determine the effects of training group, aircraft type (i.e., flight school), the interaction between these two factors, and the logarithm of the subject's total flight time as a covariate. The resulting F-ratios are small except for that testing the effects of ground school (Group 1 versus Groups 2, 3, 4). The significance of ground instruction as measured in the written quiz improvement scores is determined by the F-ratio (3.70) and degrees of freedom (1, 46), which gives a confidence of 94 percent.

The anova was also applied to several observations from the evaluation flights. The anova model was used to test for the effects of training group, evaluation pilots, change in log total time, and the change in recency. The results of the significance tests are summarized in Table 7, which indicates that flight training has a significant effect on the change in subjective evaluation grades.

5.4 CORRELATION ANALYSIS

The analysis of variance treats only one dependent variable at a time, whereas multivariate techniques permit the analyst to evaluate interactions among numerous observed quantities simultaneously. This subsection discusses one of these multivariate analyses, correlation analysis. Appendix E contains the results of applying factor analysis and discriminant analysis to the data.

The correlation matrix presents an indication of the statistical dependence among the experimentally observed variables. Each element of the correlation matrix ρ_{ij} is a measure ($-1 \leq \rho_{ij} \leq +1$) of the linear association between the two respective variables; diagonal terms ($i = j$) are always unity since each variable is perfectly correlated with itself.

Table 8 presents the correlation matrix for seventeen selected observation variables. All correlation coefficients whose magnitude is less than 0.25 have been omitted for ease of analysis. The most highly correlated variables ($\rho_{ij} = 0.9$) are the log total time at the two evaluations (indices 1 and 3) and the normalized time out of and number of times out of slow flight (indices 10 and 11). Moderate to strong correlations are also evident between other recency and log total time variables. Another

TABLE 7. SUMMARY OF ANOVA CONFIDENCE LEVELS.

Dependent Variable*	Variable No. (Table 5)	Training Group	Eval. Pilots	Ground School (Groups 2,3,4)	Flight Training (Groups 3,4)	Spin Training (Group 4)	Δ Log Total Time	Δ Recency
Subjective Improvement Grade	77				88			
Δ Evaluation Grade	106				94			
Δ Altitude Control	104	82	96	84	93	83		
Δ Heading Control	105		95		79	86		
Δ Rudder Coordination	103						88	78
Δ $\frac{\# \text{ Times Out}}{\text{Slow Flight Time}}$	102			94				
Δ $\frac{\text{Time Out}}{\text{Slow Flight Time}}$	100							
Δ Average Intentional Stall Performance	Avg(46-50) -Avg(17-21)	80	96		79			

* Δ indicates change in grade between first and second evaluation flights.

TABLE 8. CORRELATION MATRIX FOR SELECTED OBSERVATION VARIABLES.

Variable*	Index	Variable Index																
		1	2	3	4	5	6	7	8	9	10	11	12	13	14	15	16	17
Log Total Time - Eval. #1	1	1.0																
Recency - Eval. #1	2	.3	1.0															
Log Total Time - Eval. #2	3	.9	.4	1.0														
Recency - Eval. #2	4	.3	.7	.4	1.0													
Δ Log Total Time	5	-.8		-.5		1.0												
Δ Recency	6		-.6			.3	1.0											
Δ Spin Experience	7	.5		.5		-.3		1.0										
Δ Average Intentional Stall Performance	8								1.0									
Δ No. Unintentional Spins	9									1.0								
Δ Normalized Time Out of Slow Flight	10										1.0							
Δ Normalized No. Times Out of Slow Flight	11										.9	1.0						
Δ Rudder Coordination	12				.3	.3			.6				1.0					
Δ Heading Control	13								.5				.4	1.0				
Δ Altitude Control	14								.5				.5	.6	1.0			
Δ Subjective Eval. Score	15								.6				.5	.5	.5	1.0		
Δ Quiz Grade	16					-.3											1.0	
Subjective Improvement Score	17								.6		-.3		.5	.5	.6	.8		1.0

NOTE: All correlations less than 0.25 have been omitted from table.

*Δ - Change in score between first and second evaluation flights.

high correlation is between the evaluation pilot's subjective improvement score (index 17) and the change in overall subjective evaluation scores (index 15), which demonstrates consistency in the evaluation scoring. Both the overall subjective scores and the subjective improvement score are also correlated with the (subjective) rudder, heading and altitude control scores (indices 12, 13 and 14) and with the average intentional stall performance grade (index 8).

The slow flight coordination scores (rudder, heading, altitude) also show a moderate correlation with the average intentional stall performance grade. The only other significant correlation appears between the increase in spin experience (index 7) and the two log total time factors (indices 1 and 3) since, as shown in Table 6, the mean flight experience of the Group 4 subjects was substantially higher than the other groups.

SECTION 6

MAJOR RESULTS AND CONCLUSIONS

This section summarizes the major results and conclusions which were derived from a careful evaluation and interpretation of all the experimental data. As noted in Section 5, the number of subjects available for this study was limited. However, the results for the smaller sample size reflect definite trends, even though a strong statistical basis was not present.

6.1 MAJOR RESULTS

Several pertinent results from the analyses in the previous section are summarized below:

1. The mean overall subjective flight evaluation grade improved for all four training groups.
2. All subjective flight evaluation grades were positively correlated.
3. The flight training had a definite effect on the improvement in the subjective flight evaluation scores.
4. As expected, the ground school had a definite effect on the written quiz scores, but the individual subject's written quiz score did not correlate with his flight performance.

A number of interesting observations can be made from Table 9, which shows the improvements in the total number of accidental stalls, unintentional spins, and evaluation pilot takeovers between the two flight evaluations.

1. For accidental stalls, comparing the group with no ground school versus the groups with ground school shows a much greater improvement by those with the training:

	No. Subj.	Flight Eval. No. 1	Flight Eval. No. 2	% Improvement
No Ground School (1)	9	90	63	30
Ground School (2 + 3 + 4)	41	341	164	52

Consequently, the ground school was effective in reducing the number of accidental stalls.

TABLE 9. IMPROVEMENT IN UNINTENTIONAL STALLS, SPINS, AND TAKEOVERS.

Training Group	No. Subjects	Accidental Stalls			Unintentional Spins			Takeovers		
		Flight Eval.		% Improvement	Flight Eval.		% Improvement	Flight Eval.		% Improvement
		No. 1 (22-35)	No. 2 (51-64)		No. 1 (34)	No. 2 (63)		No. 1 (35)	No. 2 (64)	
1	9	90	63	30	2	1	50	1	1	0
2	9	125	45	64	2	5	-150	4	4	0
3	14	106	61	42	6	4	33	4	2	50
4	18	110	58	47	9	0	100	5	0	100
All	50	431	227	47	19	10	47	14	7	50

NOTE:

$$\% \text{ Improvement} = \frac{\text{No. 1} - \text{No. 2}}{\text{No. 1}} \times 100 \text{ percent}$$

Numbers in parentheses refer to variables in Table 5.

2. For unintentional spins, comparing the group with spin training and the groups without spin training gives:

	No. Subj.	Flight Eval. No. 1	Flight Eval. No. 2	% Improvement
Spin Training (4)	18	9	0	100
No Spin Training (1+2+3)	32	10	10	0

Hence, spin training was effective in preventing unintentional spins on the second evaluation.

3. For evaluator takeovers, comparing the group with spin training versus the groups without spin training gives:

	No. Subj.	Flight Eval. No. 1	Flight Eval. No. 2	% Improvement
Spin Training (4)	18	5	0	100
No Spin Training (1+2+3)	32	9	7	22

Again, spin training was effective in eliminating takeovers by the evaluator.

4. The extra stall and slow flight training was not sufficiently different from normal training to influence the occurrence of accidental stalls:

	No. Subj.	Flight Eval. No. 1	Flight Eval. No. 2	% Improvement
No Extra Stall Training (1+2)	18	215	108	50
Extra Stall Training (3+4)	32	216	119	45

This data actually shows a slightly greater improvement without extra training, but the difference is insignificant.

5. The extra stall and slow flight training was effective in preventing unintentional spins:

	No. Subj.	Flight Eval. No. 1	Flight Eval. No. 2	% Improvement
No Extra Stall Training (1+2)	18	4	6	-50
Extra Stall Training (3+4)	32	15	4	73

Additional flight training did not show any detectable difference in performance over normal flight training in reducing accidental stalls, but it was significant in reducing unintentional spins. A possible explanation for the lack of improvement in accidental stall performance is that the regular training syllabus already encompasses intentional stall training, and the first evaluation gave all subjects an introduction to inadvertent stall practice.

6. The extra stall and slow flight training was also effective in eliminating takeovers by the evaluator:

	No. Subj.	Flight Eval. No. 1	Flight Eval. No. 2	% Improvement
No Extra Stall Training (1+2)	18	5	5	0
Extra Stall Training (3+4)	32	9	2	78

7. The additional training consisted of only two additional hours which was the same as the duration of the evaluation flights. Unfortunately, there is no way to evaluate subjects without effectively giving them some training, and there is no way to determine the training effectiveness of the evaluation flights. The number of accidental stalls improved as a result of exposure to the evaluation itself as shown by the 30 percent improvement by Group 1.

6.2 CONCLUSIONS

Definite trends in the statistical results presented in this report support the following conclusions:

1. The effectiveness of the ground training is better sensed by flight performance than by written testing. Additional ground training in the subject of stalls and spins tends to reduce the occurrence of unintentional stalls and spins.

2. Additional flight training on stall awareness and/or intentional spin training has a positive influence toward reducing inadvertent stalls and spins.
3. The most effective additional training was slow flight with realistic distractions, which exposed the subjects to situations where they are likely to experience inadvertent stalls.

REFERENCES

1. National Transportation Safety Board, Special Study - General Aviation Stall/Spin Accidents, 1967-1969. NTSB-AAS-72-8, September 1972.
2. Hollister, W. M., LaPointe, A., Oman, C. M., and Tole, J. R., Identifying and Determining Skill Degradations of Private and Commercial Pilots. Report No. FAA-RD-73-91, September 1973.
3. Federal Aviation Administration, Flight Training Handbook, FAA AC 61-21, U.S. Government Printing Office, 1965.
4. Afifi, A. A., and Azen, S. P., Statistical Analysis - A Computer Oriented Approach, Academic Press, New York, 1972.
5. Gibra, I. N., Probability and Statistical Inference for Scientists and Engineers, Prentice-Hall, Englewood Cliffs, New Jersey, 1973.
6. Dixon, W. J. (ed.), BMD Biomedical Computer Programs, University of California Press, Berkeley, California, 1974.

BIBLIOGRAPHY

1. Adams, W. M., Jr., Analytic Prediction of Airplane Equilibrium Spin Characteristics. NASA TN D-6926, November 1972.
2. Anglin, E. L., and Scher, H., Analytical Study of Aircraft-Developed Spins and Determination of Moments Required for Satisfactory Spin Recovery. NASA TN D-2181, 1964.
3. Anglin, E. L., Relationship Between Magnitude of Applied Spin Recovery Moment and Ensuing Number of Recovery Turns. NASA TN D-4077, 1967.
4. Beech Aircraft Corporation, Flight Manual. Jeppesen, 1974.
5. Beech Aircraft Corporation, Private Pilot Manual, Revised. Jeppesen, 1973.
6. Bihrlle, W., Jr., Floating Characteristics of Rudders and Elevators in Spinning Attitudes as Determined from Hinge-Moment-Coefficient Data with Application to Personal-Owner-Type Airplanes. NACA TN 2016, 1950.
7. Blodget, R., "Spins," *Flying Magazine*, November 1972, p. 86ff.
8. Bowman, J. S., Jr., "Airplane Spinning," *Astronaut. & Aeronaut.*, Vol. 4, No. 3, March 1966, pp. 64-67.
9. Bowman, J. S., Jr., and Burk, S. M., Jr., Stall/Spin Research Status Report. SAE Paper 740354, Business Aircraft Meeting, Wichita, Kansas, April 1974.
10. Bowman, J. S., Jr., and Burk, S. M., Jr., Stall/Spin Studies Relating to Light General-Aviation Aircraft. SAE Paper 730320, Business Aircraft Meeting, Wichita, Kansas, April 1973.
11. Bowman, J. S., Jr., Summary of Spin Technology as Related to Light General Aviation Airplanes. NASA TND-6575, December 1971.
12. Burk, S. M., Jr., Summary of Design Considerations for Airplane Spin-Recovery Parachute Systems. NASA TN D-6866, August 1972.
13. Carter, C. V., A Discussion of Theoretical Methods for Prediction of Spin Characteristics. Rep. No. 10732, Chance Vought Aircraft, Inc., February 1957.
14. Cessna Aircraft Company, Cessna 150 Commuter - Pilot's Operating Handbook - 1976 Model 150M.
15. Chapman, G. C., An Experimental Assessment of a Ground Pilot Trainer in General Aviation. AD 653 736, Ohio State University, February 1966.
16. Chevalier, H., and Brusse, J. C., A Stall/Spin Prevention Device for General-Aviation Aircraft. SAE Paper 730333, Business Aircraft Meeting, Wichita, Kansas, April 1973.

17. Crook, W. G., Experimental Assessment of Ground Trainers in General Aviation Pilot Training. NAFEC Report FAA-ADS-67-5, April 1967.
18. Dixon, W. J. (ed.), BMDP Biomedical Computer Programs. University of California Press, Berkeley, California, 1975.
19. Easter, M., and Hubbard, W., Experimental Training Program Utilizing an Integrated VFR-IFR Curriculum. FAA-DS-68-24, August 1968.
20. Ericksen, S. E., A Review of the Literature on Methods of Measuring Pilot Proficiency. Research Bulletin 52-25, Human Resources Research Center, Lackland Air Force Base, Texas, 1952.
21. Federal Aviation Administration, Airplane Flight Instructor Written Test Guide. FAA AC 61-118, Revised 1972.
22. Federal Aviation Administration, FAA Approved Airplane Flight Manuals, Placards, Listings, Instrument Markings - Small Airplanes. FAA AC 60-6, December 13, 1968.
23. Federal Aviation Administration, Flight Instructor's Handbook. FAA AC 61-16A, 1969.
24. Federal Aviation Administration, Flight Test Guide Private Pilot Airplane, Part 61. FAA AC 61-54, Revised 1973.
25. Federal Aviation Administration, Hazards Associated with Spins in Airplanes Prohibited from Intentional Spinning. FAA AC 61-67, February 1, 1974.
26. Federal Aviation Administration, Improvements Required to Reduce Aircraft, Engine, and Systems Failure and Human Error Types of Accidents. FAA Data Report No. 1, Project No. 560-100-01X, October 1969.
27. Federal Aviation Administration, Part 61 (Revised) Certification: Pilot and Flight Instructors. FAA AC 61-65, September 5, 1973.
28. Federal Aviation Administration, Pilot's Spatial Disorientation. FAA AC 60-4, February 9, 1965.
29. Federal Aviation Administration, Private and Commercial Pilots Refresher Courses. FAA AC 61-10A, 1972.
30. Federal Aviation Administration, Private Pilot (Airplane) Flight Training Guide. FAA AC 61-2A, Revised 1964.
31. Federal Aviation Administration, Report on Results of Chi-Square Analysis of the Accidents of Selected Makes and Models of General Aviation Aircraft for Period 1964-1971. FAA Data Report Activity No. 184-520-010, September 1973.
32. Federal Aviation Administration, Student Pilot Guide. FAA AC 61-12F, 1974.

33. Federal Aviation Administration, Use of Approach Slope Indicators for Pilot Training. FAA AC 61-47, September 16, 1970.
34. Federal Aviation Administration National Aviation Facilities Experimental Center, Reduction of Stall/Spin Accidents Related to Take-Off, Departure and Landing. NA-68-4, February 1968.
35. Federal Aviation Regulations for Pilots, Parts 1, 61, 71, 91, 95, 97, and 430. October 1975.
36. Fink, M. P., Shivers, J. P., and White, L. C., Wind-Tunnel Tests of a Full-Scale Model of a Light Twin-Engine Airplane with Fixed Auxiliary Airfoil or Leading-Edge Slot. NASA TN D-7474, April 1974.
37. Flexman, R. E., Townsend, J. C., and Orstein, G. N., Evaluation of a Contact Flight Simulator When Used in an Air Force Primary Pilot Training Program. I. Total Effectiveness. AFPTRC-TR-54-38, 1954.
38. Forrest, F. G., Objective Flight Test for the Certification of a Private Pilot. FAA-DS-70-17, May 1970.
39. Forrest, F. G., Angle of Attack Presentation in Pilot Training. FAA-DS-69-6, March 1969.
40. Gandelman, J. H., Evaluation of Angle of Attack Instrumentation in the Training of Student Pilots to Private Pilot Certification. FAA-DS-68-19, August 1968.
41. General-Aviation Safety. Flight International, September 11, 1975, p. 360.
42. Gilbert, W. P., and Libbey, C. E., Investigation of an Automatic Spin-Prevention System for Fighter Airplanes. NASA TN D-6670, 1972.
43. Grafton, S. B., A Study to Determine Effects of Applying Thrust on Recovery from Incipient and Developed Spins for Four Airplane Configurations. NASA TN D-3416, 1966.
44. Greer, G. D., Smith, W. D., and Hatfield, J. L., Manual of Instruction on Use of Pilot Performance Description Records in Flight Training Quality Control. Human Resources Research Office, Fort Rucker, Alabama, 1959.
45. Grumman American Aviation Corporation, Private Pilot Training Syllabus. FAR Part 141, Revised. Jeppesen Sanderson, 1975.
46. Hay, G. C., "VFR-IFR Experimental Training Program," Presented to Third Annual R&D Report to Industry, June 10, 1969.
47. Houston, R. C., Smith, J. F., and Flexman, R. E., Performance of Student Pilots Flying the T-6 Aircraft in Primary Pilot Training. AFPTRC-TR-54-109, 1954.

48. Ingram, D. L., Notes on a Flight Grading System for Aircrew Pilot Candidates. Technical Note 66-5, Canadian Forces Personnel Applied Research Unit, November 1966.
49. Ingram, D. L., A Report on the Use of a Light Aircraft as a Pilot Selection Device. Technical Report 67-4, Canadian Forces Personnel Applied Research Unit, March 1967.
50. Isley, R. N., and Caro, P. W., Jr., Use of Time Lapse Photography in Flight Performance Evaluation. 1970.
51. Jenkins, J. G., "Selection and Training of Aircraft Pilots," Journal of Consulting Psychology, 1941.
52. Jones, J. P., "Spins for Proficiency and Recovery," Flight Operations, April 1976, pp. 38-40.
53. Jones, J. P., "Stalls," Flight Operations, March 1976.
54. Kellogg, W. N., "The Learning Curve for Flying an Airplane," Journal of Applied Psychology, 1946.
55. Lockwood, V. E., Effect of Reynolds Number and Engine Nacelles on the Stalling Characteristics of a Model of a Twin-Engine Light Airplane. NASA TN D-7109, December 1972.
56. McElroy, C. E., An Approach to Stall/Spin Flight Test of Maneuvering-Type Aircraft. AGARD-CP-85, AGARD Conference Proceedings No. 85 on Flight Test Techniques, May 1971.
57. McVeigh, M. A., and Kisielowski, E., A Design Summary of Stall Characteristics of Straight Wing Aircraft. NASA CR-1646, June 1971.
58. Miller, N. (ed.), Psychological Research on Pilot Training. Army Air Force Aviation Psychology Program Research Report No. 8, Washington, D. C.: U. S. Government Printing Office, 1947.
59. Muse, T. C., chairman, Panel Discussion - "Where Do We Go From Here?" Presented at the Stall/Post-Stall/Spin Symposium, Wright-Patterson AFB (Ohio), December 1971, pp. ZZ-1-ZZ-25.
60. Nagay, J. A., A Report of Progress on the First Steps in the Development of a Procedure for Measuring the Proficiency of Private Pilots. American Institute for Research Report, February 1950.
61. Neese, J. A., Description of Audio/Visual Recording Equipment and Method of Installation for Pilot Training. AMRL-TR-68-73, October 1968.
62. Neihouse, A. I., Klinar, W. J., and Scher, S. H., Status of Spin Research for Recent Airplane Designs. NASA TR R-57, 1960. (Supersedes NACA RM L57F12).

63. Neihouse, A. I., Lichtenstein, J. H., and Pepoon, P. W., Tail-Design Requirements for Satisfactory Spin Recovery. NACA TN 1045, 1946.
64. Neihouse, A. I., Tail-Design Requirements for Satisfactory Spin Recovery for Personal-Owner-Type Light Airplanes. NACA TN 1329, 1947.
65. Neihouse, A. I., The Aileron as an Aid to Recovery from the Spin. NACA TN 776, 1940.
66. Neihouse, A. I., The Effect of Variations in Moments of Inertia on Spin and Recovery Characteristics of a Single-Engine Low-Wing Monoplane with Various Tail Arrangements, Including a Twin Tail. NACA TN 1575, 1948.
67. Ontiveros, R. J., Capabilities, Necessary Characteristics and Effectiveness of Pilot Ground Trainers, Phase II, Visual Reference Flight Maneuvers. FAA-RD-73-108, August 1973.
68. Phillips, C. R., Jr., An Experimental Assessment of a Ground Pilot Trainer in General Aviation. AD 653 729, Miami-Dade Junior College, January 1966.
69. Piper Aircraft Corporation, Piper Instrument Commercial Manual, Jeppesen, 1974.
70. Piper Aircraft Corporation, Piper Instrument Commercial Flight Briefers Manual, Jeppesen, 1974.
71. Piper Aircraft Corporation, Piper Private Pilot Flight Briefers Manual, Second Edition, Jeppesen, 1974, Supplement, 1975.
72. Piper Aircraft Corporation, Piper Private Pilot Manual, Jeppesen, 1975.
73. Purifoy, G. R., Jr., Instructional Methodology and Experimental Design for Evaluating Audio/Video Support to Undergraduate Pilot Training. AFHRL-TR-68-5, October 1968.
74. Rutan, B., "Aerodynamic Design Approach to the Stall/Spin Problem - The VariViggen," SAE Paper 740391, Business Aircraft Meeting, Wichita, Kansas, April 1974.
75. Seidman, O., and Neihouse, A. I., Free-Spinning Wind-Tunnel Tests of a Low-Wing Monoplane With Systematic Changes in Wings and Tails. V. Effect of Airplane Relative Density. NACA Rep. 691, 1940.
76. Silver, B. W., "Statistical Analysis of General Aviation Stall Spin Accidents," SAE No. 760480, SAE Business Aircraft Meeting, Wichita, Kansas, April 1976.

77. Smetana, F. O., et al., Light Aircraft Lift, Drag, and Moment Prediction - A Review and Analysis. NASA CR-2523, May 1975.
78. Smith, J. F., and Flexman, R. E., An Instructional Manual for Using Performance Record Sheets Designed for Primary Pilot Training. Human Resources Research Center.
79. Smith, J. F., Flexman, R. E., and Houston, R. E., Development of an Objective Method of Recording Flight Performance. Human Resources Research Center Technical Report 52-15, 1952.
80. Smode, A. F., Hall, E. R., and Meyer, D. E., An Assessment of Research Relevant to Pilot Training. AMRL-TR-66-196, November 1966.
81. Society of Experimental Test Pilots, Pilot's Handbook for Critical and Exploratory Flight Testing. Prepared by the Society of Experimental Test Pilots and AIAA, 1972.
82. Stanek, P., Study of Capabilities, Necessary Characteristics and Effectiveness of Pilot Ground Trainers, Vol. I - Main Text. FAA-RD-72-127, I, January 1973.
83. Stanek, P., Study of Capabilities, Necessary Characteristics and Effectiveness of Pilot Ground Trainers, Vol. II - Addendum, Summary of Flight Instructors' Views. FAA-RD-72-127, II, January 1973.
84. Stone, R. W., Jr., Garner, W. G., and Gale, L. J., Study of Motion of Model of Personal-Owner or Liaison Airplane Through the Stall and Into the Incipient Spin by Means of a Free-Flight Testing Technique. NACA TN 2923, 1953.
85. Strickler, M. K., and Eggspuehler, J. J., "General Aviation Safety: Fact and Fiction," AIAA Student Journal, Winter 1974/1975.
86. Townsend, J. C., and Flexman, R. E., Suggested Ways of Improving Instruction in the Primary Pilot Training Program. AFPTRC-TR-54-126, 1954.
87. U. S. Civil Aeronautics Administration, Civil Pilot Training Manual, Civil Aeronautics Bulletin No. 23, 2nd Edition, September 1941.
88. U.S. Civil Aeronautics Administration, Flight Instruction Manual, CAA Technical Manual No. 100, April 1951.
89. U.S. Civil Aeronautics Administration, Flight Instructor's Handbook, CAA Technical Manual No. 105, January 1956.
90. U.S. Civil Aeronautics Board, Aircraft Design-Induced Pilot Error. February 1967.

91. U.S. Air Force, Military Specification, Stall/Post-Stall/Spin Flight Test Demonstration Requirements for Airplanes. MIL-S-83691, March 31, 1971.
92. U.S. Air Force, Air Training Command, Flying Training, T-37 Aircrew Training (Mission Support). ATC Manual 51-37, January 30, 1975.
93. U.S. Air Force, Air Training Command, Flying Training, Applied Aerodynamics. ATC P-V4A-A-AA-SW, April 1975.
94. U.S. Air Force, Air Training Command, Flying Training, Undergraduate Pilot Training, Airmanship, ATC Study Guide/Workbook. ATC P-V4A-A-AM-SW, August 1974.
95. U.S. Air Force, Air Training Command, Primary Flying, Jet. ATC Manual 51-4, July 5, 1974.
96. U.S. Air Force, Air Training Command, Syllabus of Instruction for Undergraduate Pilot Training. ATC Syllabus P-V4A-A, July 1975.
97. U.S. National Transportation Safety Board, Annual Review of Aircraft Accident Data, U.S. Air Carrier Operations, 1970-1972. NTSB-ARC-74-1, April 1974.
98. U.S. National Transportation Safety Board, Annual Review of Aircraft Accident Data, U.S. Air Carrier Operations, 1973. NTSB-ARC-74-2, October 1974.
99. U.S. National Transportation Safety Board, Annual Review of Aircraft Accident Rate, U.S. General Aviation, Calendar Year 1972. NTSB-ARG-74-3, November 1974.
100. U.S. National Transportation Safety Board, A Preliminary Statistical Analysis of Aircraft Accident Data, U.S. Civil Aviation, 1974. NTSB-APA-74-1, February 1975.
101. U.S. Naval Aviation Schools Command, Stall/Spin Training Programmed Instruction Manual, Excerpts from the Navy's T343 Manual.
102. E. W. Wiggins Airways, Inc., Flight School, Catalogue No. 17, Vol. 1.
103. Wilcoxon, H. C., Johnson, W., and Golan, D. L., The Development and Tryout of Objective Check Flights in Pre-Solo and Basic Instrument States of Naval Air Training. U.S. Naval School of Aviation Medicine, Pensacola, Florida, 1952.
104. Winblade, R. L., and Westfall, J. A., "NASA General Aviation Research Overview - 1975," SAE Paper No. 750500, Business Aircraft Meeting, Wichita, Kansas, April 1975.
105. Winblade, R. L., "NASA in General Aviation Research Past-Present-Future," SAE Paper 730317, Business Aircraft Meeting, Wichita, Kansas, April 1973.

106. Woolman, M., A Preliminary Analysis of an Anchored Subjective Grading Method. Air Training Command Final Project Report TA&D-55-7, 1955.
107. Woolman, M., Evaluating Flight Performance. Air Training Command Final Project Report TA&D-55-1, 1955.
108. Young, J. W., Optimal and Suboptimal Control Technique for Aircraft Spin Recovery. NASA TN D-7714, October 1974.

APPENDIX A

This appendix is a reproduction of the handbook developed for all subjects for the ground training increment.

STALL AWARENESS PROGRAM NOTES

Prepared by

AEROSPACE SYSTEMS, INC.
One Vine Brook Park
Burlington, Massachusetts 01803

for

Federal Aviation Administration
800 Independence Avenue
Washington, D. C. 20591

January 1976

SECTION 1

DESCRIPTION OF THE STALL AWARENESS TRAINING PROGRAM

WHY A STALL AWARENESS PROGRAM?

The stall is perhaps flying's oldest danger; that it is a continuing and costly hazard is evidenced by general aviation accident statistics. Stall/spin accidents occur in general aviation aircraft at an average rate of one a day. About one-third of these accidents result in one or more fatalities so that the number of lives lost to stall/spin accidents is almost as great as the total number of stall/spin accidents occurring. Stall/spin related accidents account for about one quarter of the total general aviation fatal accidents, the greatest single cause. The pilots who are involved in these accidents are not limited to those with low levels of experience. According to the NTSB statistics, one third of the stall/spin accidents involve pilots with over 1000 hours experience. The median experience of a pilot involved in a stall/spin accident is around 400 hours. Stall/spin accidents are usually caused by a distraction of the pilot from his primary task of flying the aircraft. Few of the pilots who were stall/spin accident victims intended to stall the aircraft. Sixty percent of stall/spin accidents occur during takeoff or landing. Twenty percent are preceded by engine failure. Other distractions include preoccupation with something on the ground or in the cockpit, slowing behind traffic, climbing to clear obstacles, abrupt changes in power, configuration or trim.

The question which results is, "How can a pilot be prevented from falling victim to these traps and distractions?" One approach is to warn him just before the aircraft is about to stall. This has been done by requiring a stall warning device which activates at high angle of attack. Stall warning has reduced the stall/spin accident rate, but has not eliminated the problem. Another approach is to design the aircraft to be less susceptible to inadvertent stalls. Work has been done and is still going on to improve aircraft stall characteristics, but that has not yet solved the problems either.

A third answer is to improve the training of the pilot so that he is less susceptible to the traps which lead him into an inadvertent stall. That is the purpose of this Manual; to put the emphasis on AVOIDING THE UNINTENTIONAL STALL. The justification for this approach is that previous training emphasized the execution of an intentional stall, while the accident problem is created by unintentional stalls which result from distractions. The approach in this manual is to educate the pilot about the situations which lead to an unintentional stall, and give him practice in avoiding unintentional stalls when challenged by distractions. A spin cannot occur until an aircraft has stalled, so that proper stall avoidance also provides spin avoidance. Spin avoidance training would include instruction on the recovery from an incipient spin, but would not include instruction on intentional spins.

In the following pages there is detailed information about the stall/spin accident rate, about how aircraft are certificated for spins, the aerodynamics of stalls and spins, and techniques to help you avoid inadvertent stalls and spins.

SECTION 2

GENERAL AVIATION STALL SPIN ACCIDENTS

Stall/spin accidents involving general aviation aircraft have historically accounted for more fatal and serious injuries than any other single type of accident. Although improvement has been evidenced over the past several decades as a result of better flight training and aircraft design, these types of accidents remain a very serious threat to safety in general aviation. Ever-increasing public acceptance and utilization of the airplane make it important to reduce the number of these accidents. Because of the anticipated increases in fleet size and total general aviation flight hours, the number of stall/spins may be expected to escalate. However, renewed accident-prevention efforts can serve to reverse this trend. Consequently, in 1972 the National Transportation Safety Board emphasized the need for new research efforts and training programs aimed at reducing these types of accidents.

The Safety Board maintains records of all aircraft accidents that occurred during and subsequent to 1964. The data on stall/spin accidents during the three-year period from 1967 to 1969 can be summarized as follows:

- a. A total of 1,261 stall/spin accidents were recorded during the three-year period 1967 through 1969. These accounted for only about 8 percent of the total number of accidents but were responsible for 997 fatalities and 464 serious injuries - about 24 percent of the total of all fatal or serious accident injuries sustained during this period.
- b. Sixty-one percent of all stall/spin accidents reviewed were associated with non-commercial flying; 19 percent were associated with instructional flying; 14 percent were associated with commercial flying; and 7 percent were associated with flying of a miscellaneous kind.
- c. Twenty-four percent of the stall/spin accidents occurred during takeoff; 36 percent occurred during landing; and 40 percent occurred during the inflight phase. Most of the accidents in this latter phase were related to "acrobatics," "buzzing," "low passes," etc.

- d. The pilot was considered a broad cause/factor in about 97 percent of the 744 occurrences in which a stall/spin was considered to be the primary accident type.
- e. Significant miscellaneous acts and conditions associated with stall/spin accidents included "unwarranted low flying," "flew into blind canyon," "poorly planned approach," "alcoholic impairment of efficiency and judgment," "improperly loaded aircraft, weight, and/or c.g.," etc.
- f. About 25 percent (247) of the 991 stall/spin accidents reviewed were preceded by other types of accidents, including 190 engine failures or malfunctions.
- g. The broad cause/factor categories assigned to the engine failure/malfunction accidents included the pilot in 54 percent of the cases, the powerplant in 39 percent of the cases, and personnel in about 13 percent of the cases.
- h. Significant miscellaneous acts and conditions relating to the engine failure/malfunction accidents included "anti-icing/deicing equipment-improper operation of/failed to use," "fuel exhaustion," "ice-carburetor," "simulated conditions," "fuel starvation," etc.

THE STALL/SPIN TYPE OF ACCIDENT

The lift generated by an airplane wing increases as angle of attack and air-speed are increased. For a given airplane weight and altitude, a low angle of attack is required at relatively high speeds, and a high angle of attack is required at relatively low speeds. However, at very high angles, i.e., at or beyond the stalling angle, the ability of the wing to generate lift is markedly reduced because of airflow separation, and wing stall is encountered. As a result, lift is considerably reduced and drag is significantly increased.

Recovery from a stalled condition is quite simple in conventional aircraft if sufficient altitude is available. The angle of attack must be decreased and the air-speed increased. The airspeed at which the stall occurs is the stalling speed and is defined for level, unaccelerated flight as the "the minimum speed in flight at which the airplane can develop a lift equal to the weight of the airplane, the lift being the

aerodynamic force perpendicular to the flightpath." The altitude required for recovery varies from one airplane to another but for the power-off configuration, several hundred feet is typical of most light single-engine airplanes.

A stall may occur at any airspeed, depending on the load factor or "g" force that is generated, since it is a function only of the critical angle of attack of the wing. A stall that occurs at speeds higher than the minimum speed as defined above is called an accelerated stall. Accelerated stalls often occur during aerobatics, buzzing, aerial application, etc., where the associated maneuvers are characterized by steep pullups or steep turns. The classification of an accident as a stall type of accident is based on statements from the pilot and/or the observations of eyewitnesses, the attitude of the airplane, the conditions and circumstances of flight prior to impact, and an evaluation of the ground and wreckage evidence. The intent of this total evaluation is to corroborate flight at or beyond the stalling angle of attack.

A spin, because of the abrupt entry, rapid rate of rotation, and general disorienting effect, is considerably more violent than a stall. A spin results when a sufficient degree of rolling or yawing control input is imposed on an airplane in the stalled condition. Without a stall, a spin cannot occur. Thus, an accidental spin might result from stalling an aircraft due to "failure to obtain/maintain flying speed" in conjunction with "improper operation of the flight controls." With controls fixed in the pro-spin direction, the spin rotation, once initiated, is generally self-sustaining. The control inputs and the altitude required for recovery are much more critical for spins than for stalls, and spins at relatively low altitudes, even incipient spins where the rotation has not fully developed, are generally catastrophic. The substantiation of an incipient spin, however, is often difficult or impossible since the spin motion prior to impact may not be developed sufficiently to enable an eyewitness to observe the rotation or to result in conspicuous ground/wreckage patterns.

STALL/SPIN STATISTICS

A. THE ACCIDENT RECORD

During the post World War II period, 1945 through 1948, stall/spin accidents accounted for about 48 percent of all fatal general aviation accidents. For the three year period 1967 through 1969, they accounted for 22 percent of all fatal occurrences. The 1,261 stall/spin accidents recorded during this time resulted in only about 8 percent of the total number of accidents but were responsible for 997 fatalities and 464 serious injuries, about 23.5 percent of the total of all fatal or serious accident injuries sustained during this period.

According to one study, by 1980 the general aviation fleet will number close to a quarter of a million aircraft, more than double the size of the 1967 fleet, and will fly about 63 million hours annually, about three times the total flight hours recorded in 1967. Thus, although a substantial relative improvement in stall/spin accident statistics appears to have been evidenced in past years, the increased size and growth rate of general aviation makes further improvement imperative.

B. PILOT CERTIFICATE/WEATHER CONDITIONS/LIGHTING CONDITIONS

The pilots involved in 991 of the stall/spin accidents, according to certificate, included 166 students, 425 private pilots, 203 commercial pilots, 163 commercial flight instructors, and 34 others. 956 of the accidents occurred during VFR weather conditions, 29 during IFR conditions, 5 in conditions unknown or not reported, and 1 in conditions below minimums. 892 of the accidents occurred during daylight, 54 at night, 40 at dusk, 4 at dawn, and 1 in unknown or unreported lighting conditions.

C. KIND OF FLYING

60.5 percent of all the stall/spin accidents studied were associated with non-commercial flying, primarily related to pleasure, practice, and business flights. 19 percent were associated with instructional dual, solo, and training flights. 14 percent were associated with commercial flying, principally in connection with aerial application or crop-control, and the remaining 6.5 percent involved flights of a miscellaneous kind.

D. PHASE OF OPERATION

238, or 24 percent, of the stall/spin accidents occurred during the takeoff phase of flight, all but one of these occurring during the initial climb. 395, or 40 percent, occurred during the in-flight phase, but only 70 of these, or 7 percent of the study group, could be accounted for in the specific phases described as "climb to cruise," "normal cruise," and "descending." The other 325 in-flight accidents, in all except four cases, were associated with "acrobatics," "buzzing," "low passes," agricultural and various other operations. The remaining 358 stall/spin accidents, or 36 percent of the study group, occurred during the landing phase of flight, with most related specifically to "traffic pattern-circling," "final approach," and "go-around."

Fatal stall/spins numbered 73 in the takeoff phase, 107 in the landing phase, and 235 in the in-flight phase. The ratio of fatal stall/spin occurrences to the total number of stall/spin occurrences within a given phase of flight was approximately the same in both takeoff and landing (about 30 percent). In the in-flight phase, however, this ratio was about twice as great (about 60 percent).

E. STALL/SPIN ACCIDENT SEQUENCE

In 744 of the 991 accidents, the stall/spin was cited as a first accident type. The remaining 247 stall/spins were classified as second accident types, i.e., they were

preceded by other occurrences, including 190 engine failure/malfunctions, 25 overshoots, 10 undershoots, 8 groundloops, 9 hard landings, and 5 other miscellaneous accident types. Approximately 43 percent of the engine failure/malfunctions occurred during the takeoff phase of flight, almost all of these during the initial climb; 43 percent occurred during various in-flight phases; and 14 percent during various landing phases.

F. BROAD AND DETAILED CAUSES AND FACTORS

The pilot was considered a broad cause/factor in about 97 percent of the first type stall/spin accidents and is cited most frequently in connection with failure to obtain/maintain flying speed. The latter was recorded as a detailed cause/factor in 667 of these cases. Numerous other significant but less frequently related detailed cause/factors involving the pilot included "attempted operation beyond experience/ability level," "diverted attention from operation of aircraft," "continued VFR flight into adverse weather conditions," "inadequate preflight preparation and/or planning," "improper operation of flight controls," "improper in-flight decisions or planning," "exercised poor judgment," "inadequate supervision of flight," "physical impairment," and "misused or failed to use flaps." Another rather significant broad cause/factor was weather, which was related to about 16 percent of these first type stall/spins. The details were associated with cause/factors such as "low ceilings," "fog," "icing conditions," "unfavorable wind conditions," "down-drafts," "updrafts," "high temperature," "high density altitude," etc. The broad cause/factor "miscellaneous" was associated with about 4 percent of the cases and included detailed cause/factors such as "evasive maneuver to avoid collision," and "unqualified person operating aircraft."

Certain other miscellaneous acts and conditions associated with the aforementioned accidents are also considered significant. These include "unwarranted low flying" (in 106 instances), "poorly planned approach," "flew into blind canyon,"

"alcoholic impairment of efficiency and judgment," and "improperly loaded aircraft-weight and/or c.g."

The pilot was considered to be a broad cause/factor in about 54 percent of the 190 engine failure/malfunction type accidents preceding stall/spins. The detailed cause/factors tabulated most frequently were "improper operation of powerplant and powerplant controls," "inadequate preflight preparation and/or planning," and "mismanagement of fuel." Other broad cause/factor categories included the powerplant, cited in about 39 percent of the cases, with "powerplant failure for undetermined reasons" being detailed in about half of all such instances; personnel, cited in about 13 percent of the cases, primarily in connection with "inadequate maintenance and inspection;" "weather" in about 8 percent of the cases, with "conditions conducive to carburetor/induction system icing" being the most frequently tabulated detail; and miscellaneous in about 5 percent of the cases. The miscellaneous acts and conditions most frequently tabulated in connection with these engine failure/malfunction type accidents were "anti-icing/deicing equipment - improper operation of/failed to use," "fuel exhaustion," "ice-carburetor," "simulated conditions," and "fuel starvation."

The broad cause/factors associated with the remaining types of accidents preceding stall/spins, i.e., overshoot, undershoot, groundloop, etc., are related primarily to the pilot and weather.

PILOT INVOLVEMENT SUMMARY

Some years ago a review of FAA airmen examinations suggested that the stall/spin problem appears partially related to a lack of knowledge and awareness of factors affecting a stall. It is also evident, however, based on the correlation of stall/spin accidents with "phase of flight," that the majority of stall/spins occur under conditions which distract the pilot and substantially divide his total attention

between performance and control of the airplane and external references, operational contingencies, etc. 60 percent of the stall/spins studied, for example, occurred during takeoff and landing, and 33 percent during in-flight acrobatics, buzzing, low passes, etc.

In connection with airplane performance, it should be noted that many of these stall/spins were precipitated by an engine failure or malfunction caused by mismanagement of fuel, improper operation of powerplant and powerplant controls, and inadequate preflight preparation and/or planning.

The pilot's attentiveness to airplane performance in terms of monitoring and controlling airspeed and responding to stall warning is often compromised by contingencies and critical circumstances which develop as a direct result of his own actions, e.g., unwarranted low flying, misuse of flaps, poorly planned approach, and inadequate preflight preparation and/or planning. These factors, as well as those relating to the above-mentioned occurrences of engine failure/malfunction, relate generally to pilot competence, proficiency, education, and judgment.

Some specific examples of pilot-involved factors, circumstances, and conditions which, based on a review of selected accidents, are related directly or indirectly to the stall/spin occurrence include:

- unwarranted low flying
- fuel exhaustion due to inadequate preflight preparation and/or planning
- fuel starvation due to mispositioning of fuel selector
- alcoholic impairment of efficiency and judgment
- poorly planned approach
- lack of familiarity with aircraft

- continuing VFR flight into adverse weather conditions
- diverted attention from operation of aircraft
- water in fuel
- premature lift-off
- improperly loaded aircraft-weight and/or c.g.
- inadequate soft- or short-field technique
- attempting takeoff from unimproved or inadequate fields
- attempting takeoff or go-around with wing flaps improperly extended
- inadequate landing go-around technique
- inadequate crosswind takeoff or landing technique
- abortive attempts to clear obstacles
- poor judgment and/or technique in simulated forced landings
- general lack of proficiency in takeoff or landing during windy, turbulent conditions.

SECTION 3

SPINS

WHAT IS A SPIN?

The spin has been defined as an aggravated stall which results in autorotation. It is a motion in which an airplane whose wing is in a stalled condition descends rapidly towards the earth in a helical path, rotating about a vertical axis. Wing angles of attack in the spin are between stalling and 90° . Associated pitch attitudes may vary from level to vertically nose down to slightly inverted. The spinning motion is very complicated and involves simultaneous rolling, yawing, and pitching while the airplane is at high angles of attack and sideslip. Since it involves separated flows in the region beyond the stall, aerodynamic characteristics of the airplane are very nonlinear and time dependent. Thus, at the present time, the spin is not very amenable to theoretical analyses.

The overall spin maneuver can be considered to consist of three phases: the incipient spin, the developed spin, and the recovery.* An illustration of the various phases of the spinning motion is given in Figure A-1.

The incipient spin occurs from the time the airplane stalls and rotation starts until the spin axis becomes vertical or nearly vertical. During this time the airplane flight path is changing from horizontal to vertical, and the spin rotation is increasing from zero to the fully developed spin rate. The incipient spin usually occurs rapidly in light airplanes (4 to 6 seconds, approximately) and consists of approximately the first two turns. As indicated by full-scale tests and by the model tests, the typical incipient-spin motion starts during the stall with a roll-off. Then, as the nose drops the yawing motion begins to build up. About the half-turn point, the airplane is pointed almost straight down but the angle of attack is usually above that of the stall because of the inclined flight path (see Figure A-1). As the one-turn point is approached, the nose

*Bowman, J. S., Jr.: Summary of Spin Technology as Related to Light General Aviation Airplanes. NASA TND-6575, December 1971.

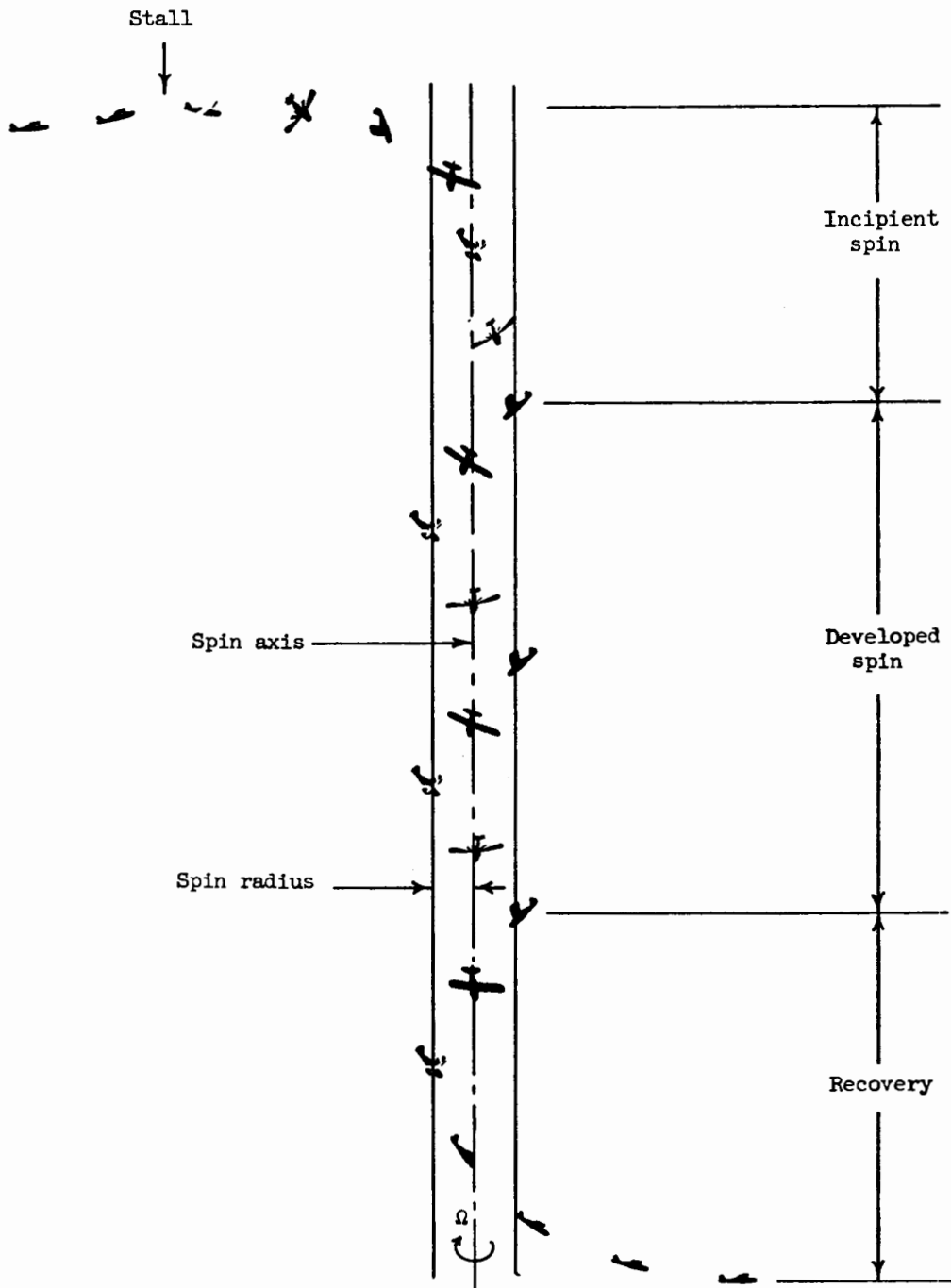

(a) Complete spin, stall through recovery.

FIGURE A-1. ILLUSTRATION OF SPINNING MOTION.

may come back up and the angle of attack continues to increase. As the airplane continues to rotate into the second turn, the flight path becomes more nearly vertical, and the pitching, rolling, and yawing motions become more repeatable and approach those of the fully developed spin shown in Figure A-1.

In the developed spin the attitude, angles and motions of the airplane are somewhat repeatable and stabilized from turn to turn, and the flight path is approximately vertical. The spin is maintained by a balance between the aerodynamic and inertia forces and moments. The spinning motion is made up of rotation about the airplane center of gravity plus translatory motion of the center of gravity; however, it is primarily a rotary motion, and it is affected mainly by the moments acting on it. A typical example of an airplane spinning motion and the forces in a spin is illustrated in Figures A-2 and A-3.

The third phase as shown in Figure A-1, the recovery, is caused by a control application such as to upset the balance between the aerodynamic and inertia moments. The specific control movements required in any particular airplane depend on certain mass and aerodynamic characteristics, but they are similar for most small airplanes.

THIS IS THE MOST IMPORTANT INSTRUCTION YOU WILL READ!

1. Reduce throttle to idle and neutralize ailerons.
2. Apply and hold full rudder opposite to the direction of rotation. If the spin was unintentional and disorientation prevents determining the direction of rotation, refer to the turn needle or turn coordinator to establish direction of rotation. Do not refer to the ball indicator.
3. Just after the rudder reaches the stop, move the control wheel briskly forward far enough to break the stall. Full down elevator may be required.
4. Hold these control inputs until rotation stops.
5. As the rotation stops, neutralize rudder and smoothly recover from the resulting dive. Retract flaps before exceeding flap extension speed.

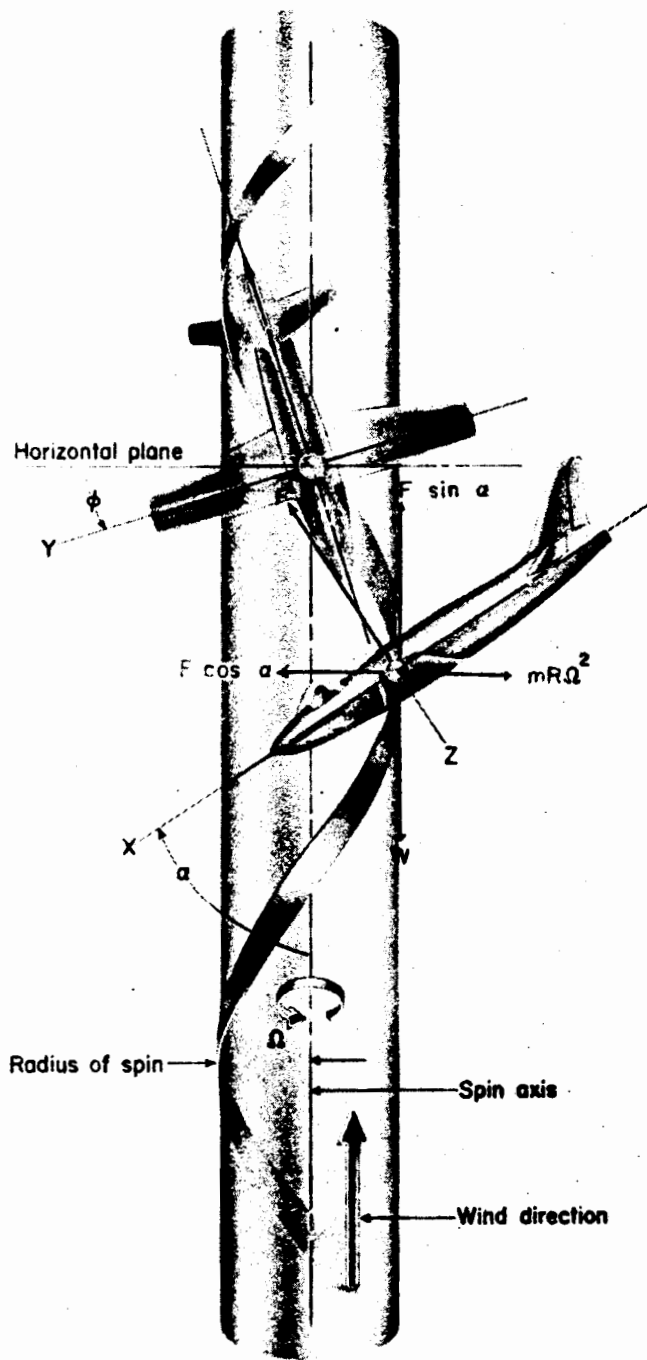

FIGURE A-2. BALANCE OF FORCES IN A SPIN.

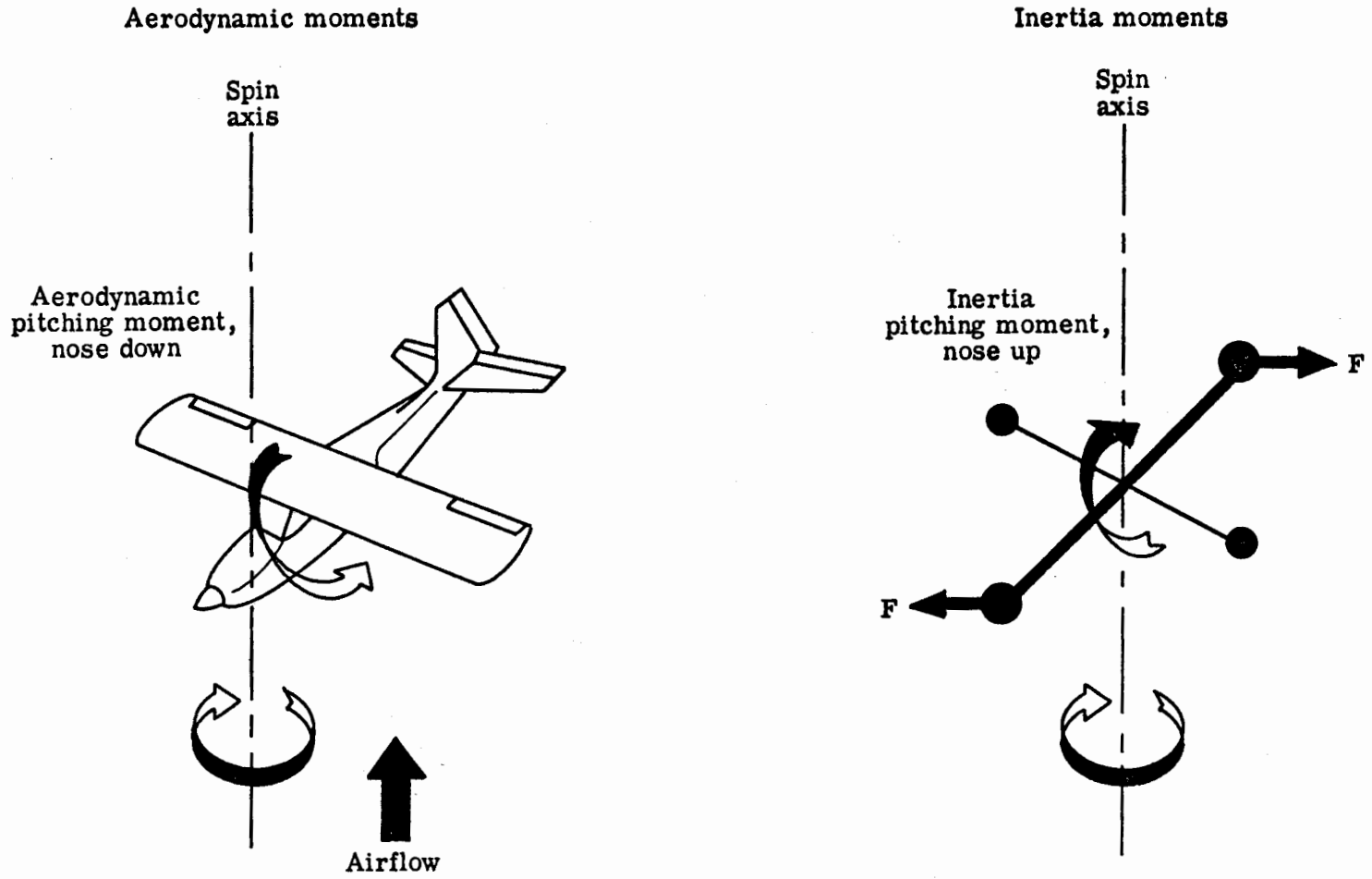

FIGURE A-3. BALANCE OF AERODYNAMIC AND INERTIA PITCHING MOMENTS IN A SPIN.

SECTION 4

STALL AVOIDANCE

SCANNING

The preceding sections have alerted you to the conditions under which inadvertent stall/spin accidents occur. The individual pilot can increase his safety by developing stall awareness to avoid inadvertent stalls. The major cause of inadvertent stall is distraction, and the best protection against this is for the pilot to develop a scan pattern that keeps his attention moving back and forth between the aircraft, the instruments, and outside references. For instrument flying, scanning is the term applied to the continuous systematic observation of the flight instruments. The actual technique may vary with different individuals and different maneuvers, but the concept is to keep the eyes moving from instrument to instrument so that the pilot gets a complete picture of the aircraft's status, rather than only one coordinate.

Most individuals throughout their lifetime have learned to apply full concentration on a task at hand in order to perform the task well. However, this tendency toward complete concentration on one thing tends to introduce a common error that defeats the purpose of scanning. The common error is to stare at a single instrument in an attempt to get that indication right. For example, while performing a turn, the pilot may have a tendency to watch the turn indicator throughout, instead of including other instruments in the scan. This usually results in loss of altitude because of poor pitch control. Although scanning is usually taught to instrument students, it is equally important for contact flying. The difference is that the scan must be largely outside the cockpit for attitude reference during VFR flying and in order to look for other aircraft. A good VFR scan pattern should take the pilot's attention from the left horizon to the instrument panel to the right horizon and back at least once every 15 seconds. The pilots who do the best in stall avoidance practice are those who are able

to divide their attention by keeping up a good scan pattern. When something happens to distract them, they simply include the distracting feature as part of their scan, but never stop their focus of attention on any single item for more than a few seconds at a time. The pilot can also be made aware of the scenarios that lead to distraction. When one occurs, it will be a reminder to keep the scan going rather than to focus on the distraction.

Until angle-of-attack indicators are common in general aviation aircraft, the airspeed indicator will remain the most important instrument for maintaining stall awareness. Most pilots are well aware of the importance of keeping flying speed near the ground. Consequently, near the ground the airspeed indicator is the primary cockpit instrument that is cross-checked together with the outside environment. The object is to prevent the scan from breaking down.

CRITICAL PHASES OF FLIGHT

The specific purpose of this manual is to provide a means of reducing the stall/spin accident rate. Therefore, it is useful to discuss some ways in which stall/spin accidents occur as a means of helping pilots avoid these situations.

Preflight Planning

Proper preflight planning is essential. A thorough check of current and forecast weather conditions before and continuing during the flight will assure that a VFR pilot does not enter instrument weather conditions or have an inadvertent stall/spin while trying to avoid terrain and deteriorating weather. Careful planning will assure that sufficient fuel is on board the airplane so that the flight is completed with adequate reserves including any diversions to an alternate airport which may become necessary. Careful fuel planning and management during flight will prevent fuel exhaustion/starvation, which is often followed by a stall/spin during an attempted forced landing.

The airplane should be loaded within the approved weight and center of gravity limits. Overloading causes a loss of takeoff and climb performance which may be critical under standard conditions, and especially so during operations from a high elevation airport or in high ambient temperatures. The loss of takeoff performance may make it impossible to clear obstacles in the takeoff/climb path. The pilot may attempt to climb more steeply by applying full nose-up elevator, causing a departure stall/spin. If center of gravity limits are not observed and the airplane is loaded behind the aft center of gravity limit, stability is reduced (or lost altogether), stalling characteristics are affected, and spin recovery may be impossible.

Careful preflight inspection of the airplane itself should be conducted. Many departure stall/spins follow an engine failure on takeoff due to fuel contaminated by water. A fuel sample from all drain points should be taken in a clear glass to inspect for water, and sufficient fuel should be drained. Fuel quantity is checked visually. The dynamic and static pressure ports should be clear to prevent erroneous airspeed indications. Particular care must be taken to assure that the aircraft is completely free of ice, snow, and frost. Even a 1/4" accumulation of snow or ice will alter the contours of aerodynamic surfaces enough to reduce their lifting ability and increase drag and stalling speeds. Many stall/spin accidents occur when an airplane stalls just after becoming airborne because its flying characteristics and performance are altered by ice on the wings, tail, controls, propeller, etc. Frost must also be removed before flight since it roughens the skin surfaces of the airplane, causing increased skin friction drag, lengthened takeoff run, and loss of climb performance. Snow or ice may also obstruct fuel tank vents and air intakes with resultant fuel starvation or power loss, so they should also be checked.

Takeoff and Departure

The pre-takeoff check should be accomplished with a checklist. Aside from insuring normal functioning of airplane and engine, it will preclude the possibility of takeoff with improper trim or flap settings. Either can cause the pilot to inadvertently stall the airplane during the takeoff or initial climb. Correct positioning of the fuel selector to the fullest tank will insure that fuel starvation does not cause an engine stoppage.

Thorough instruction and practice will improve the pilot's takeoff technique. In tricycle gear airplanes, rotation to takeoff attitude should occur only after the recommended airspeed has been attained, and attitude control should be as precise as possible while the airplane accelerates from liftoff to climb speed. This will preclude the possibility of premature liftoff, which may cause the airplane to settle back to the runway, and which also may increase the distance required to climb over obstacles. Precise attitude control after liftoff will quicken acceleration to best climb speed and prevent too nose-high a pitch attitude from causing a stall or loss of airspeed. If flaps are used for takeoff, they should be retracted slowly only after safe flying speed has been attained and all obstacles are cleared. If they are retracted rapidly or at too low an airspeed, the airplane may stall.

A particularly difficult subject is the question of power loss during the takeoff or initial climb. If this occurs, the nose must be immediately lowered to best glide attitude to prevent a stall and loss of control. Many stall/spin accidents have occurred because a pilot attempted to turn back to the airport following a power failure on takeoff. Every pilot should be familiar with the altitude his airplane loses in a power-off 180° turn back to the airport. This can be determined at a safe altitude by starting a climb, reducing power to idle, lowering the nose to avoid a stall, and

obtaining best glide speed, then executing a gliding 180° turn. The low airspeed and nose-up attitude in a climb adds to the altitude loss in the turn, since altitude must be sacrificed first to maintain flying speed. If the failure occurs below this altitude, do not under any circumstances attempt to turn back. It is likely to result in a stall/spin. It is better to land the airplane straight ahead, under control, than to spin into the ground out of control. Careful check of the fuel supply, fuel selector, and engine operation before takeoff are the best measures to prevent power failure on takeoff.

Approach and Landing

In the traffic pattern and on approach and landing, many factors are competing for the pilot's attention. He must learn to divide his attention so that the tasks of aircraft control, traffic observation and spacing, and radio communications are accomplished safely. Because so many complex tasks must be performed simultaneously, distraction or concentration on one task can cause the pilot to neglect the primary task of aircraft control and stall/spin. Also, poor knowledge and execution of safe operating techniques is often responsible for stall/spin accidents in the traffic pattern.

Perhaps the most serious errors of basic flying technique in the traffic pattern involve airspeed and altitude control, airplane configuration and power management, maintenance of correct ground track and proper execution of turns. Airspeed control is of prime importance since the airplane must be flown with reduced margins above stalling speed during approach and landing. Especially in the traffic pattern the pilot must be aware of airspeed at all times. The most frequent errors leading to an approach stall/spin are likely to be made during the turn from base to final. There is less margin for error at this point since the stalling speed is increased in the turn.

Usually the plane will be trimmed nose-up, as it should be at this point to help maintain correct approach speed. The pilot should be aware though, that in the nose-up trim position, only a relatively small increase in back pressure can produce a stall. If the pilot begins to overshoot the turn onto final, he may steepen the bank and/or use excessive rudder pressure to yaw the airplane onto final. Either of these actions causes the nose to pitch down. If the pilot then adds more back elevator pressure to hold the nose up, an accelerated stall may result with the airplane yawing in an uncoordinated turn and a spin will follow quickly. The best method of avoiding this situation is proper planning of the traffic pattern and frequent scanning between the airspeed indicator, altimeter, ball indicator, and outside visual references. Careful planning and compensation for wind on downwind and base legs will place the airplane in position to make a coordinated, gentle turn from base to final. If the downwind leg is flown at the correct pattern altitude of 1000 feet AGL, there is less possibility that safety will be compromised by flying the base leg, base to final turn, or final approach too low. On downwind, altitude should be maintained ± 100 feet, and descent below pattern altitude should not begin until the airplane is abeam the approach end of the runway. The turn to base should be made at a position and altitude such that the airplane could glide to the runway in the event of engine failure. A minimum altitude of 500 ft. AGL should be observed for the turn from base to final to provide a safety margin in the event of a stall. Particular care must be given to flap extension. In some airplanes it is accompanied by a tendency to pitch nose up, which can result in a loss of too much airspeed unless the pilot compensates with elevator and trim control. From the standpoint of safety, it is not wise to extend full flaps until the base to final turn is completed. When full flaps are extended, the airplane's rate of descent increases. This can cause the altitude to become too low during the base to final turn. If the pilot attempts to reduce his rate of descent while in the turn by adding back elevator pressure, a stall may follow. Once the

airplane is established on final, full flaps may be extended as necessary, but only within gliding range of the runway. Pitch attitude and power should be set to hold recommended approach airspeed and correct rate of descent. In other words, the approach should be stabilized. A final trim adjustment should be made at this time. If the aircraft is sinking too rapidly on final and appears to be descending to a point short of the runway threshold, power should be added followed by a pitch increase. If a pitch increase alone is made to reduce the rate of descent, a loss of airspeed or possibly a stall will follow, depending on what pitch attitude is used. Also, if the airplane is in the area of reversed command, an increase in pitch attitude without an increase in power will only increase the rate of descent. Care should be taken in reducing the throttle as the runway threshold is neared. A sudden, rapid reduction of power will cause an increase in rate of descent. If an attempt to check this descent is made with back elevator, a loss of flying speed can occur. Especially in turbulent conditions, it is useful to use partial power during the final approach. This lessens the possibility that entry to a gust will momentarily change the direction of the relative wind and stall the airplane. Power should be reduced to idle as the elevators are brought aft in the landing flare. If this technique is used, the tendency to increase the rate of descent when power is reduced is cancelled by the tendency to stop descending as the elevators are brought aft to increase the pitch attitude and angle of attack. One further factor which should be mentioned is the effect of headwind on the approach path angle. If a pilot begins the final approach at a certain distance from the runway (say 1/2 mile), then for a particular power setting and rate of descent, the stronger the headwind, the steeper the flight path angle. The stronger headwind thus tends to make the pilot undershoot his approach and renders him more vulnerable to errors in pilot technique which may cause a stall. (For example, an airplane making an approach at 60 m.p.h. airspeed and 500 ft/min rate of descent will make

no forward progress in a 60 m.p.h. headwind, so the flight path in theory becomes vertical.) Thus, under strong headwind conditions, the pilot should anticipate the use of a higher than normal descent power setting. This will reduce the possibility of his approaching too low and stalling because of improper control technique in stopping his rate of descent.

Since so many variables enter into flying an approach, a pilot must develop the skill and knowledge of how to allocate his attention to handle the workload involved. This ability is vital to his safety during approach and landing.

The go-around or aborted landing presents a somewhat different set of circumstances. On the approach, the pilot devotes all his efforts to getting down to a landing. When the decision to go around is made, the effort is quickly reversed, and he wants to climb out again. Thus, he may not be prepared for the go-around and may make an error in its execution. For this reason the go-around and cleanup procedure must be executed promptly, deliberately, and in correct sequence by the pilot. A pilot should not be reluctant to abandon an approach which is not going well. This is particularly true if the aircraft is too low, too slow, or not lined up with the runway on final, since these situations can lead to a low altitude stall. The decision to go-around should be made early enough so that obstacle clearance on climbout from the departure end of the runway is assured. A departure stall can result from this cause, especially if full flaps were set during the approach and they are left fully extended while a climbout is attempted. Most light airplanes have marginal climb capability with full flaps, especially at high elevations, or in hot, humid weather. Such a departure stall is likely to be in a yawed condition and may be quickly followed by a spin. No specific go-around procedure applies to all light aircraft, but when the decision to go around is made, the pilot should first add full

power while raising the nose to level pitch altitude. The pitch increase must be handled carefully, as a too nose-up attitude could cause an immediate stall. As power is applied, the airplane tends to pitch nose up and a strong push is required on the control wheel to prevent the nose from pitching up into a stall. This is one instance where the pilot must override the elevator control forces, hold correct pitch attitude, and not "let the airplane fly him." Most airplanes have an intermediate flap setting to which the flaps should then be retracted. Retraction to this setting will hasten acceleration to climb airspeed by reducing drag with only a small associated increase in stalling speed. If the flaps are retracted rapidly or fully, the airplane may stall or lose altitude. This altitude loss can become critical in terms of obstacle clearance at the departure end of the runway. As the airplane accelerates to climb airspeed, the pitch may be slowly increased to begin a climb. Further flap retraction should not be done until safe airspeed is reached and the airplane has cleared all obstacles.

Engine Failure

A large number of stall/spin accidents occur following an engine failure. Since the probability of a safe forced landing is very high if the pilot maintains control of the airplane after the engine failure, perhaps the most critical threat to safety under these conditions is the stall/spin accident. Emergency procedures are reviewed and discussed frequently during pilot training, so we will not go into them here, except to say that the probability of survival from any forced landing is much higher than that from a developed spin.

For a good discussion of this subject, the student is referred to NTSB Report No. NTSB-AAS-72-3, entitled, "Emergency Landing Techniques in Small Fixed-Wing Aircraft."

SECTION 5

INTENTIONAL SPINS

This section presents material pertinent to spin training taken from a pamphlet by Cessna Aircraft Company entitled, "Spin Characteristics of Cessna Models 150, A150, 172 and 177." Although it specifically concerns Cessna aircraft, it is generally relevant to all light aircraft.

The subject of airplane spinning is a complex one, which is often oversimplified during hangar-flying sessions. There are increasing numbers of pilots, including flight instructors, who, because of the structure of present pilot certification requirements, have had little or no training in spins and spin recovery. This has resulted in some confusion and misunderstanding over the behavior of airplanes in spinning flight, and it appears that this lack of understanding may have contributed to some serious accidents. In the interest of expanding each pilot's knowledge and increasing the safety of his operations, some factors influencing spin behavior as it pertains to the Cessna Models 150, A150, 172, and 177 which are approved for intentional spins will be discussed.

The following list summarizes important safety points relative to the performance of intentional spins.

Basic Guidelines for Intentional Spins

1. Know your aircraft thoroughly.
2. Prior to doing spins in any model aircraft, obtain thorough instruction in spins from an instructor fully qualified and current in spinning that model.
3. Be familiar with the parachute, airspace and weather requirements of FAR 91.15 and 91.71 as they affect your flight.
4. Check the aircraft weight and balance to be sure you are within the approved envelope for spins.
5. Secure or remove all loose cockpit equipment prior to takeoff.

6. Be sure the area to be used is suitable for spins and is clear of other traffic.
7. Enter each spin at a high altitude. Plan recoveries to be completed well above the minimum legal altitude of 1500 feet above the surface.
8. Conduct all entries in accordance with the procedures recommended by the manufacturer.
9. Limit yourself to 2-turn spins until completely familiar with the characteristics of your airplane.
10. Use the following recovery procedures for the Cessna Models 150, 172, and 177:
 - a. Verify that the throttle is in idle and ailerons are neutral.
 - b. Apply and hold full rudder opposite to the direction of rotation.
 - c. Just after the rudder reaches the stop, move the control wheel briskly forward far enough to break the stall. Full down elevator may be required at aft center of gravity loadings in some airplane models to assure optimum recoveries.
 - d. Hold these control inputs until rotation stops. Premature relaxation of the control inputs may extend the time for recovery and altitude loss.
 - e. As the rotation stops, neutralize rudder and make a smooth recovery from the resulting dive.

For the purpose of this discussion, the spin will be divided into three distinct phases. These are the entry, incipient, and steady phases, illustrated in Figure A-1. The basic cause of a spin is a difference in lift and drag between the two wings with the airplane operating in essentially stalled flight. Entry to this condition is initiated, intentionally or otherwise, when the airplane is stalled in uncoordinated flight. This causes one wing to reach a higher angle of attack than the other. Beyond stall angles of attack, lift begins decreasing while drag rises rapidly. This causes a sustained autorotation to begin because of the decreased lift and increased drag of one wing half as compared to the other.

Here, in the entry phase, recovery from or prevention of the spin is as simple as normal stall recovery since, in fact, at this point that is all we are really faced with. Coordinated use of rudder and aileron to oppose any tendency to roll should be applied with emphasis on the rudder due to its generally more powerful influence at this point. This should be accompanied by relaxation of elevator back pressure to reduce the angle of attack below that of the stall. Coordinated use of all controls should then be applied to return to normal level flight. During this entry phase, recovery of control (or prevention of loss of control) will normally be instantaneous for all practical purposes as soon as the stall is broken.

The second, or incipient phase, covers that period of time from the spin entry to the fully stabilized spin. During this period the yaw being produced by a deflected rudder while the airplane is stalled is supplemented by the differences in lift and drag between the two wing panels. These parameters cause the rotating motion of the airplane to begin to increase.

During this incipient phase, spin recoveries in those airplanes approved for intentional spins are usually rapid, and, in some airplanes, may occur merely by relaxing the pro-spin rudder and elevator deflections. However, positive spin recovery control inputs should be used regardless of the phase of the spin during which recovery is initiated. Briefly, these control inputs should be (1) power off, (2) full rudder opposite to the direction of rotation, (3) just after the rudder reaches the stop, elevator briskly forward to break the stall, and (4) as rotation stops, neutralize the controls and recover from the resulting dive. Using these procedures, recoveries are typically accomplished in from $1/8$ to $1/2$ turn during the incipient phase.

The final phase is the fully developed "steady" phase. Here, a more-or-less steady state spin results where the autorotational aerodynamic forces (yaw due to

rudder deflection, lift and drag differences across stalled wing) are balanced by the centrifugal and gyroscopic forces on the airframe produced by the rotating motion. Due to the attitude of the airplane in a spin, the total motion is made up of rolling and usually pitching motions, as well as the predominant yawing motions. Movement of the airplane flight controls affects the rate of motion about one of the axes. Because of the strong gyroscopic influences in the spin, improper aerodynamic control inputs can have an adverse affect on the spin motion.

Aileron variations from neutral can cause a different balance between the aerodynamic, inertia and gyroscopic forces and cause some delay in recoveries. Typically even a slight inadvertent aileron deflection in the direction of the spin will speed up rotation and delay recoveries. Moving the elevator control forward while maintaining pro-spin rudder deflection may not provide a recovery with some airplanes. In fact, reversing the sequence of rudder-elevator inputs or even just slow, rather than brisk, inputs may lengthen recoveries. Finally, it is important, particularly in this steady spin phase, in addition to using the correct control application and the proper sequence of control application, to HOLD THIS APPLICATION UNTIL THE RECOVERIES OCCUR. In extreme cases, this may require a full turn or more with full down elevator deflection.

The proper recovery control inputs to obtain optimum recovery characteristics in Cessna single engine airplanes are repeated here and amplified somewhat from those listed under the incipient phase.

1. Verify that the throttle is in idle and ailerons are neutral.
2. Apply and hold full rudder opposite to the direction of rotation.
3. Just after the rudder reaches the stop, move the control wheel briskly forward far enough to break the stall. Full down elevator may be required at aft center of gravity loadings in some airplane models to assure optimum recoveries.

4. Hold these control inputs until rotation stops. Premature relaxation of the control inputs may extend the recovery.
5. As the rotation stops, neutralize rudder and make a smooth recovery from the resulting dive.

The emphasis added to these steps differentiates the steady phase from the incipient phase. The most important difference in the steady phase is an increase in the length of recoveries in this phase for some airplanes, and to a lesser extent the amount of control input needed. Up to a full turn or more to recover is not unusual in this phase. Full down elevator deflection will sometimes be needed to assure optimum recoveries at aft loadings in some airplanes. **IT IS VERY IMPORTANT TO APPLY THE RECOVERY CONTROLS IN THE PROPER SEQUENCE AND THEN HOLD THEM UNTIL RECOVERY OCCURS.**

Some of the additional factors which have (or may have) an effect on spin behavior and spin recovery characteristics are aircraft loading (distribution, center of gravity and weight), altitude, power, and rigging.

Distribution of the weight of the airplane can have a significant effect on spin behavior. The addition of weight at any distance from the center of gravity of the airplane will increase its moment of inertia about two axes. This increased inertia independent of the center of gravity location or weight will tend to promote a less steep spin attitude and more sluggish recoveries. Forward location of the center of gravity will usually make it more difficult to obtain a pure spin due to the reduced elevator effectiveness. Conversely, extremely aft center of gravity locations will tend to promote lengthened recoveries since a more complete stall can be achieved. Changes in airplane gross weight as well as its distribution can have an affect on spin behavior since increases in gross weight will increase inertia. Higher weights may extend recoveries slightly.

High altitudes will tend to lengthen recoveries since the less dense air provides less "bite" for the controls to oppose the spin. However, this does not suggest the use of low altitudes for spin practice.

Airplane rigging can have a strong influence on spin characteristics. Improper elevator and rudder deflection stops can alter the depth of entry into a spin and also can alter the amount of recovery control available. Low cable tensions can alter the amount of travel available at the control surface and may thus reduce the control power available for either entry to an intentional spin or recovery.

Power can affect the spinning attitude. If power is carried in the spin, the airplane attitude may be less nose down. In addition, the propeller will tend to add some gyroscopic inputs which will be reversed between left and right spins. The effect of leaving power on during a spin may lengthen recoveries on some airplanes.

The foregoing areas have considered in the design and certification of an airplane. If the airplane is maintained and operated within manufacturers approved limitations, then spin characteristics and recoveries will be acceptable, although the trends mentioned above may be evident.

The next several paragraphs will briefly describe the typical spin characteristics of recent Cessna models approved for spins.

150F through 150L - A150K through A150L

Entries at an aft center of gravity will be positive from a power off unaccelerated stall. At more forward center of gravity locations, a slightly higher deceleration rate may be necessary.

The incipient phase rotation will be rapid and the nose will progress to an average 60° to 70° nose down attitude in the vicinity of two turns.

At aft center of gravity loadings at 2-1/2 to 3 turns as the airplane enters the steady phase, there may be evident some change in character of the spin. The nose attitude may become less steep and rise to approximately 45° to 50° below the horizon. In addition, some change in sideslip will be felt and rotation rates will change some. As the center of gravity is moved forward, this tendency to change character will disappear and spiral tendencies may appear.

Recoveries during the entry and incipient phases will vary from 1/4 to 1/2 turn typically at aft center of gravity loadings to practically instantaneous at forward center of gravity loadings. Recoveries from extended spins will vary from in excess of a full turn at aft center of gravity to 1/2 turn typically at forward center of gravity locations.

150M - A150M

Spin characteristics for this model are similar to those of the earlier models except as follows. Entries at forward center of gravity loadings will be more difficult to accomplish without more rapid deceleration.

The incipient phase will be almost the same as for the older models, but the character change upon entering the stable phase will be subdued but still evident at aft center of gravity loadings. The nose attitude change may not be evident at all, although some variation in rotation rate and sideslip may be noted.

Recoveries will be similar to those of the earlier models from all phases although a slight reduction in recovery turns (1/8 to 1/4) may be evident.

172H through 172L (1971) (Utility Category Only)

Entries at an aft center of gravity (utility aft) will be positive. At forward center of gravity locations, more rapid deceleration or some power will be necessary to obtain an entry.

The airplane will pass rapidly through the incipient phase into the steady phase with little change to note.

Recoveries in the entry and incipient phases will be up to 1/8 of a turn at aft center of gravity locations to almost instantaneous at forward centers of gravity. The steady phase recoveries will take up to 1/2 turn at aft center of gravity and to about 1/8 turn at forward center of gravity locations.

172L (1972) through 172M (Utility Category Only)

Entries at all utility loadings will be difficult to obtain unless some power and a slight amount of aileron toward the desired spin direction are applied.

Throughout the incipient phase, spiral tendencies will be evident and the airplane will usually spiral out of the spin by 2-1/2 to 3-1/2 turns even at aft center of gravity loadings (utility aft).

There is no real steady phase with this model. Recoveries initiated at any point in the spin at any loading will result in practically instantaneous recoveries.

177 through 177B (Utility Category Only)

Entries are positive although some added deceleration or power may be necessary at forward loadings.

In incipient phase, nose attitude may cycle beyond vertical during the first two turns.

In the steady phase, spiralling tendencies will be evident especially at forward loadings. Nose attitude will be in the area of 60° nose down. Recoveries during the entry and incipient phases will take no more than 1/4 turn and during the steady phase up to 3/4 turn regardless of loading.

For the purpose of training in spins and spin recoveries, a one or two turn spin will normally provide all that is necessary. All of the characteristic motions and control inputs required will have been experienced. Longer spins, while acceptable as a maneuver in appropriately certified airplanes, provide little additional insight to a student in the area of spin recovery since the prime reason for conducting a spin is to learn how to avoid an inadvertent entry in the first place and then how to recover if one should develop.

SECTION 6

STALL AND SPIN TRAINING

The fundamental criteria used in connection with most stall training maneuvers and procedures are contained in the Federal Aviation Administration's Advisory Circular 61-21, "Flight Training Handbook." The material in this section is excerpted from that handbook. It discusses the operational aspects and methods of instruction in slow flight and stalls as well as to stalls occurring during critical flight phases such as takeoff and departure, approach and landing, and accelerated maneuvers. This information relates directly to the specific stall maneuvers required during pilot certification flight tests.

Pilots must understand and appreciate numerous factors affecting the airplane stall in order to fly safely. These factors include angle of attack, airspeed, load factor, airplane weight, configuration and center of gravity, altitude, frost or ice, and turbulence.

One or more of these factors can generally be related to any stall/spin accident, either directly or indirectly. The importance of a knowledge and understanding of these fundamentals cannot be stressed too greatly.

SLOW FLIGHT AND STALLS

The maintenance of lift and control of an airplane in flight requires a certain minimum airspeed. This critical airspeed depends upon certain factors, such as gross weight of the airplane, maneuvering loads imposed by turns and pullups, and the existing density altitude.

The closer the airspeed is reduced to this critical airspeed, the less effective are the flight controls, and the more the airspeed is increased above it, the more effective they become. The minimum speed below which further controlled

flight is impossible is called the stalling speed. At this speed, one or all of the flight controls become ineffective, and the airplane loses altitude rapidly, often in an alarming attitude. The stall results from an excessively high angle of attack, relative to the flow of air over the lifting surfaces, which is a function of the airspeed, the wing loading, and the density of the air. The most easily measurable of these factors for the pilot is the airspeed.

An important feature of pilot training is the development of the ability to estimate the margin of safety above the stalling speed by the diminishing response of the airplane to the use of its flight controls. As the airspeed decreases, control effectiveness decreases disproportionately. For example, there may be a certain loss of effectiveness when the airspeed is reduced from 30 to 20 mph above the stalling speed, but there will normally be a much greater loss as the airspeed is further reduced to 10 mph above stalling.

The ability to determine the characteristic responses of any unfamiliar airplane he may fly is of great importance to the pilot. The student pilot must develop this awareness in order to safely avoid stalls in any airplane he may fly, and to operate it correctly and safely at the slower airspeeds characteristic of takeoffs, departures and landing approaches.

Instruction and practice in slow flight is the best introduction to these principles. Slow flight instruction covers two distinct flight situations: the establishment and maintenance of the airspeed appropriate for traffic patterns and landing approaches in the airplane used; and flight at the slowest airspeed at which the airplane is capable of continued controlled flight without indications of a stall.

Slow flight and simple stalls are introduced and practiced by both instrument indications and outside visual references, if the integrated method of flight

instruction is used. It is important that a pilot form the habit of frequent reference to his flight instruments during the performance of slow flight for airspeed, altitude, and attitude indications.

Instruction in flight at approach speeds includes slowing the airplane smoothly and promptly from cruising to approach speeds without changes in altitude or heading, and determining and using the appropriate power and trim settings. This can be done most smoothly by reducing the power setting to well below that needed, and resetting it to hold altitude when the desired airspeed is attained.

Instruction and practice in flight at approach speeds includes straight flight, climbs, turns, and descents.

Slow flight at minimum controllable airspeeds is practiced from straight glides, straight-and-level flight, and from medium banked (20° to 30°) gliding and level flight turns. It is performed at an airspeed just slightly above the stall, sufficient to permit maneuvering, but close enough to the stall to give the sensation of sloppy controls and ragged response to control pressures. The airspeeds used are sufficiently slow so that any further reduction in speed or increase in load factor would result in immediate indications of a stall. Slow flight is practiced in both cruising and landing configurations.

As the throttle is eased back from level-flight cruising position, the nose must be gradually raised as airspeed decreases in order that no altitude be lost. This requires aft control force (until elevator trim is adjusted) and aft elevator control movement.

As still more speed is lost, the controls become sloppy, the sound of the airflow falls off in tone level, and either wing may tend to drop, indicating that the

airplane is approaching a stall. If too much speed is lost, or too little throttle is used, further back pressure will result in an approach stall, loss of altitude, a spin, or all three.

When the throttle position has been stabilized, turns are practiced to demonstrate the lack of maneuverability in slow flight, the danger of incipient stalls, and the tendency of the plane to stall as the bank is increased. Power is increased during turns as necessary to maintain altitude.

Once slow flight at minimum controllable airspeed is set up properly for level flight, a descent at minimum controllable airspeed can be established by simply reducing power to obtain the rate of descent desired, and simultaneously adjusting the pitch attitude as necessary to maintain proper airspeed. With flaps extended, a climb at minimum controllable airspeed may not be possible due to insufficient power in excess of that required to maintain straight-and-level flight at minimum controllable airspeed. (This inability of an airplane to climb at a slow airspeed, even with maximum power, is often referred to as operating on the "back side" of the power curve.) However, in clean configuration, a climb may be made by increasing the throttle setting and adjusting the pitch attitude as necessary to maintain minimum controllable airspeed. Turns are practiced in both descending and climbing slow flight.

A stall is caused by the breaking away of the smooth flow of air over a wing or other surface due to an excessively high angle of attack. The stall is evidenced by a sudden loss of flight control effectiveness and an uncontrollable pitching of the nose in most cases. Because the most common cause of a critically high angle of attack is the failure of the pilot to maintain an airspeed adequate for his flight situation, simple stalls are introduced in conjunction with instruction in flight at minimum controllable airspeed.

The best evidence available to the pilot in an unfamiliar airplane of the approach of the stalling speed is the rapidity with which the response to movements of the flight controls decreases. The operation of airplanes at speeds near stalling is not, in itself, hazardous; however, such operation is very dangerous unless the pilot is aware of it, and is alert and able to give his full attention to the flying of the airplane.

It is therefore evident that the practice of stalls and the development of this awareness are of primary importance to the pilot's safety. The two important reasons for teaching stalls are to assist the pilot in recognizing a stall before it is too late to take corrective action, and to implant in him the habit of taking prompt and efficient preventive or curative action.

Every pilot should be familiar with the five cues which warn of an impending stall.

1. Vision is useful in stalls in checking the attitude of the airplane. This sense can be relied on only when the stall is the result of an unusual attitude of the airplane, usually when the nose is higher than the power and speed would normally warrant. The airplane can also be stalled from a normal attitude, however, in which case vision cannot aid in detecting a stall.
2. Hearing is very important, since the tone level and intensity of sounds incident to flight decrease as the speed increases. In the case of engine noises when power is used in fixed-pitch propeller aircraft, the loss of r.p.m. is particularly noticeable. The lessening of the noise made by the air passing over the structure is also noticeable, and when the stall is almost complete, vibration and its incident noises often greatly increase.
3. Kinesthesia, or the sensing changes in direction or speed of motion, is probably the most important and the best indicator to the trained and experienced pilot. If this sensitivity is properly developed, it will warn of a decrease in speed or the beginning of a settling or mushing of the airplane.
4. The feeling of control pressures is important. As speed is reduced, the resistance to pressures on the controls becomes progressively less. Pressures exerted on the controls, and the lag between their movement and the response of the airplane becomes greater, until

in a complete stall all controls can be moved with almost no resistance, and with little immediate effect on the airplane.

5. The flight instruments indicate the approach to stalls and actual stalls.

All stalls require the expenditure of power or altitude for recovery, and both if one or the other is limited. The longer it takes to sense the approaching stall, the more complete the stall is likely to become, and the greater the loss of altitude to be expected.

Power-off stalls are entered from normal glides. Speed in excess of gliding speed should not be carried into a stall entry and allowed to cause an unnaturally nose-high attitude. With the throttle closed smoothly to idling while at cruising airspeed, the airplane is held in level flight with the elevator control until the speed is reduced to that of a normal glide, as estimated from the sound and from elevator control forces, and then nosed down into a normal glide.

When this glide has been stabilized in attitude and airspeed, the nose is firmly raised with the elevators to an attitude which will obviously prevent further gliding, and which will induce a stall within a reasonable time. The proper pitch attitude may be estimated from the angle which the lower surface (high wing airplanes) or the upper surface (low wing airplanes) of the wing tip makes with the horizon, from the indications of the gyro horizon, or from an orientation of the nose relative to the horizon.

For partial stalls, recovery is initiated when the first buffeting or loss of control is noted. Emphasis is on recognizing the indications of the stall. Stall recovery can be effected with power or with recovery to a normal glide, since power is not essential for a safe stall recovery if sufficient altitude is available.

The object of instruction in stalls is not to learn how to stall an airplane from various flight situations, but how to recognize an incipient stall and take prompt corrective action. An oversimplified explanation of the correct procedure for the recovery from all stalls is (1) to reduce the angle of attack immediately, and (2) to regain a normal flight attitude with coordinated use of the flight and power controls.

First, at the indication of a stall, the nose is lowered positively and immediately. The amount of control force or movement used depends on the design of the airplane and the severity of the stall. In some planes a moderate action of the control column - perhaps slightly forward of neutral - is enough, while in others a forcible shove is required. A reverse load thrown on the wings, however, may impede, rather than speed the stall recovery. The object is to align and keep the wing chord in line with the direction of relative wind.

Second, all of the available power is applied. The throttle should be opened smoothly, but promptly. Some engines may cough and sputter if the throttle is jammed open, while others may be damaged. Even small engines may be late in producing power if the throttle is misused. Although stall recoveries can be made without as well as with power, the application of power, if available, is an integral part of the stall recovery. The greater the power used, the less need be the loss of altitude. Full power applied at the instant of a stall will not cause the over-revving of an engine equipped with a fixed-pitch propeller, due to the low airspeed existing. It may be necessary, however, to reduce the throttle setting as speed is gained in the recovery. The tachometer needle should never be allowed to pass the red line.

Third, straight-and-level flight is regained with coordinated use of all controls. During the demonstration and practice of stalls the heading should be

maintained with the liberal use of rudder. This is important, because if the nose is prevented from yawing, the airplane cannot spin.

The use of ailerons in stall recoveries was at one time considered hazardous due to the inefficient design of some older airplanes. In modern type certificated airplanes, the normal use of ailerons does not have a detrimental effect in a stall recovery.

The recovery should be planned to produce a safe recovery to normal flight with the least expenditure of altitude. In the recovery from stalls with power in the average personal-type airplane, this will require the lowering of the nose to the level flight position, or slightly below it. Diving steeply in a stall recovery will hasten the recovery from the stall, but will cause a greater loss of altitude, which might be critical in an emergency recovery from an inadvertent stall near the ground.

Stalls entered without power are practiced from both straight glides and 10°- to 30°-banked gliding turns. In stalls without power from gliding turns, care must be taken to see that the turn continues at a uniform rate until the stall occurs. After the stall occurs, the recovery is made straight ahead with the least loss of altitude, and is effected exactly in accordance with the standard recovery. Stalls from gliding turns are valuable as a safety precaution. If the gliding turn is not properly coordinated during the approach to the stall, wallowing may result when the stall occurs, or, if the airplane is in a slip, the top wing may stall first and whip down abruptly, as if to enter a spin. This may alarm a pilot who does not understand and expect it if he inadvertently stalls from a gliding turn. It does not affect the stall recovery procedure in any way. The stall is broken, heading maintained, and the wings leveled by coordinated use of the controls.

Recovery from stalls without power may be effected just as the airplane begins settling as a partial stall occurs, just after the break occurs, or after the nose has fallen through the horizon.

All of the principles which apply to stalls without power also apply to stalls entered with power, although there are some important differences in the maneuvers. The pitching of the airplane resulting from a full-stall condition with power is much more steep and rapid, and the airplane is harder to handle than during the power-off stalls. This is particularly true of the tendency to fall off on a wing.

The elevators retain their positive control longer and require that the nose be raised higher to accomplish the power stall. The rudder remains much more effective due to the presence of the slipstream. The ailerons, however, seem to be less effective than before and establish an entirely new relationship in relative control effectiveness. This is partially due to the fact that the power being applied causes the stalling speed to be lowered slightly, which decreases aileron effectiveness, and at the same time the slipstream keeps the elevators and rudder effective to a slower speed.

In stalls of this type, the torque effect will be encountered, which makes control more difficult. Recovery from power stalls is actually more rapid, since the use of power saves some of the loss of altitude during stall entry, and since the additional power will be available immediately for the recovery. The left turning tendency in these configurations may cause some aircraft to have a greater tendency to spin. The airplane will hang in a stalled condition, by reason of the power, for a longer period of time while the ineffectiveness of all controls can be demonstrated.

As in stalls without power, the nose is brought smoothly, but firmly, to an attitude of climb obviously impossible for the airplane to maintain and is held at that attitude until the stall occurs. In most conventional airplanes, it will be found that the elevator control, after assuming the stalling attitude, will be brought progressively back as the speed falls off, until, at the stall, it is against the stop.

The standard recovery is used from power stalls, just as from all others. In this case, since the throttle is already at cruise or climb position, its advance will be only slight, but of greater importance, since the stall will have been more violent and the loss of control more complete.

Stalls with power may be performed with the recovery effected just before the stall is complete and the elevators become ineffective (such a stall is called a partial stall), with the recovery just after the break while the nose is falling, or after the nose has fallen through the horizon. Takeoff-and-departure stalls also should be performed with entries from 10°- to 30°-banked climbing turns in either direction. In these entries care must be taken to see that the turn continues up until the point of the stall which often requires a crossed position of the controls, due to torque, particularly in stalls from right turns.

Recovery from the stall can be effected, both with and without the use of power, upon the student's first recognition of the stalls or after the stall has developed to such an extent that the nose has pitched down through the level flight attitude. In either case, recovery should be made by relaxing the back pressure on the elevator control and completed to straight-and-level flight by coordinated use of all flight controls.

Frequent practice should be continued on stalls by pilots of all experience levels, since the pilot whose senses are keenly developed and whose reactions are properly trained and relegated to his subconscious mind will recognize the approach of a stall long before there is any danger of loss of control, and will automatically react properly.

STALLS FROM CRITICAL FLIGHT SITUATIONS

The most critical flight situations from the standpoint of unintentional stalls are takeoff and departure, approach and landing, and the performance of abrupt maneuvers at relatively slow airspeeds. It must be understood that stalls result solely from attempts to fly at excessively high angles of attack. The angle of attack of an airplane wing in flight is determined by a number of factors. The most important factors which control the angle of attack are:

1. the airspeed
2. the gross weight of the airplane
3. the load factors imposed by maneuvering.

At the same gross weight, airplane configuration, and power setting, an airplane will consistently stall at the same indicated airspeed if no maneuvering loads or movement of the flight controls are involved. The airplane will, however, stall at a higher indicated airspeed when maneuvering loads (accelerations) are imposed by steep turns, pullups, or other abrupt changes in its flightpath. Stalls entered from such flight situations are called "accelerated maneuver stalls," a term which has no reference to the airspeeds involved or the rapidity with which a stall is invoked.

The flight situations in which stalls have been found to be critical include those which require maneuvering at relatively slow airspeeds very close to the ground, and during the performance of abrupt maneuvers at any altitude. An airplane must be operated and maneuvered during takeoffs and departures and during approaches and landings at such low altitudes that recovery from a fully developed stall may be difficult or impossible before striking the ground. Stalls which result from abrupt maneuvers tend to be more violent than unaccelerated stalls, and because they occur at higher than normal airspeeds they may be unexpected by a pilot who has not experienced and

understood them. Failure to take immediate steps toward recovery when an accelerated or uncoordinated stall is experienced may result in a complete loss of flight control, notably power spins.

The objective of stall instruction is to learn to recognize incipient stalls and respond immediately with effective recovery procedures. Because it is necessary to set up stalls from critical flight situations carefully, students sometimes wrongly assume that it is the technique of producing the type of stall concerned which is important.

The correct recovery from all stalls from critical flight situations may be summarized in three simple steps, which are not necessarily separate, but may overlap:

1. Reduce the angle of attack with the elevator control,
2. Attain straight and laterally level flight by coordinated use of the flight controls, and
3. Apply smoothly all available power.

Takeoff and departure stalls are simulated from straight climbs and climbing turns with medium banks. Airplanes with flaps and retractable gears should be in takeoff configuration, and at least the recommended climb power should be used. The use of climb power is important to demonstrate that stalls are not necessarily the result of insufficient power, but care should be taken to see that an excessively steep climbing attitude is not reached before the stall.

To avoid excessively steep nose-up attitudes on takeoff and departure stall demonstrations, the airspeed should be reduced to lift-off speed with reduced power before the throttle is advanced to the recommended climb setting. The angle of attack should then be increased smoothly until indications of a stall are experienced, without allowing the airspeed to exceed lift-off speed at any time during the stall entry. As

the angle of attack is increased, the left turning tendency of the airplane becomes very apparent, and if proper compensation with right rudder is not made, the airplane may roll or spin as it stalls.

Recovery should be initiated immediately when the first physical indication of a stall is encountered. The stall is broken by lowering the nose, and simultaneously stopping the turn and maintaining heading while the wings are being leveled by coordinated use of the controls.

Recovery from takeoff and departure stalls is completed with the airplane in straight-and-level flight at cruising speed and at cruising rpm. During the desired recovery neither cruising airspeed nor takeoff rpm should be exceeded at any time. In no case may the never-exceed placard speed or rpm be exceeded.

Approach to landing stalls are demonstrated and practiced from straight glides and medium banked gliding turns with the airplane in landing configuration. The angle of attack is smoothly and progressively increased with the elevator control until physical evidence of a stall is experienced. Stall recoveries from approach to landing stalls should be practiced both with and without the use of power.

The stalls from medium turns practiced in takeoff and departure stalls and in approach to landing stalls are both accelerated maneuver stalls, in that the stall occurs in medium banked turns at a slightly higher airspeed than it does in straight flight. Accelerated maneuver stalls, as such, however, should be demonstrated and practiced from climbing turns and level flight turns with slightly less than cruising power at a bank of at least 45°.

These stalls may be practiced with the airplane in both landing approach and cruising flight configurations. They should not be performed at airspeeds of more than 10 miles per hour above the unaccelerated stalling speed in non-acrobatic

airplanes, because of the extremely high structural loads which are imposed on the airplane, especially if there is turbulence.

Accelerated stalls are entered by establishing and maintaining the proper angle of bank, then increasing the angle of attack until a stall occurs at less than 10 m.p.h. above the unaccelerated stalling speed.

In the practice of accelerated maneuver stalls, especially, it is important to realize that the objective is not the development of competency in setting up the stall, but the development of the ability to recognize such stalls immediately, and to take prompt, effective recovery action. Recoveries should be practiced at the first indication of a stall, and after the stall has developed to the point that the nose pitches uncontrollably.

An airplane will stall from a coordinated steep turn exactly as it does from straight flight, except that the pitch and roll experienced tend to be more sudden and violent. If the airplane is slipping at the time the stall occurs, which is common in steep turns, the airplane rolls rapidly toward the outside of the turn or may spin "over the top" as the nose pitches. If the airplane is skidding, it will roll to the inside of the turn and may spin "out the bottom." If, however, the coordination of the turn at the time of the stall is accurate, the nose will pitch away from the pilot just as it does in straight flight.

In this connection, perhaps some clarification of the terms "skidding turn and slipping turn" is required. Figure A-4(a) shows a view from above an airplane in a correctly coordinated turn with constant angle of bank. Notice that the airplane longitudinal axis is aligned with the flight path and the relative wind. This airplane is therefore said to be at zero sideslip angle, and the ball indicator is centered. Figure A-4(b) shows the airplane in a turn of the same bank angle, in which too much rudder

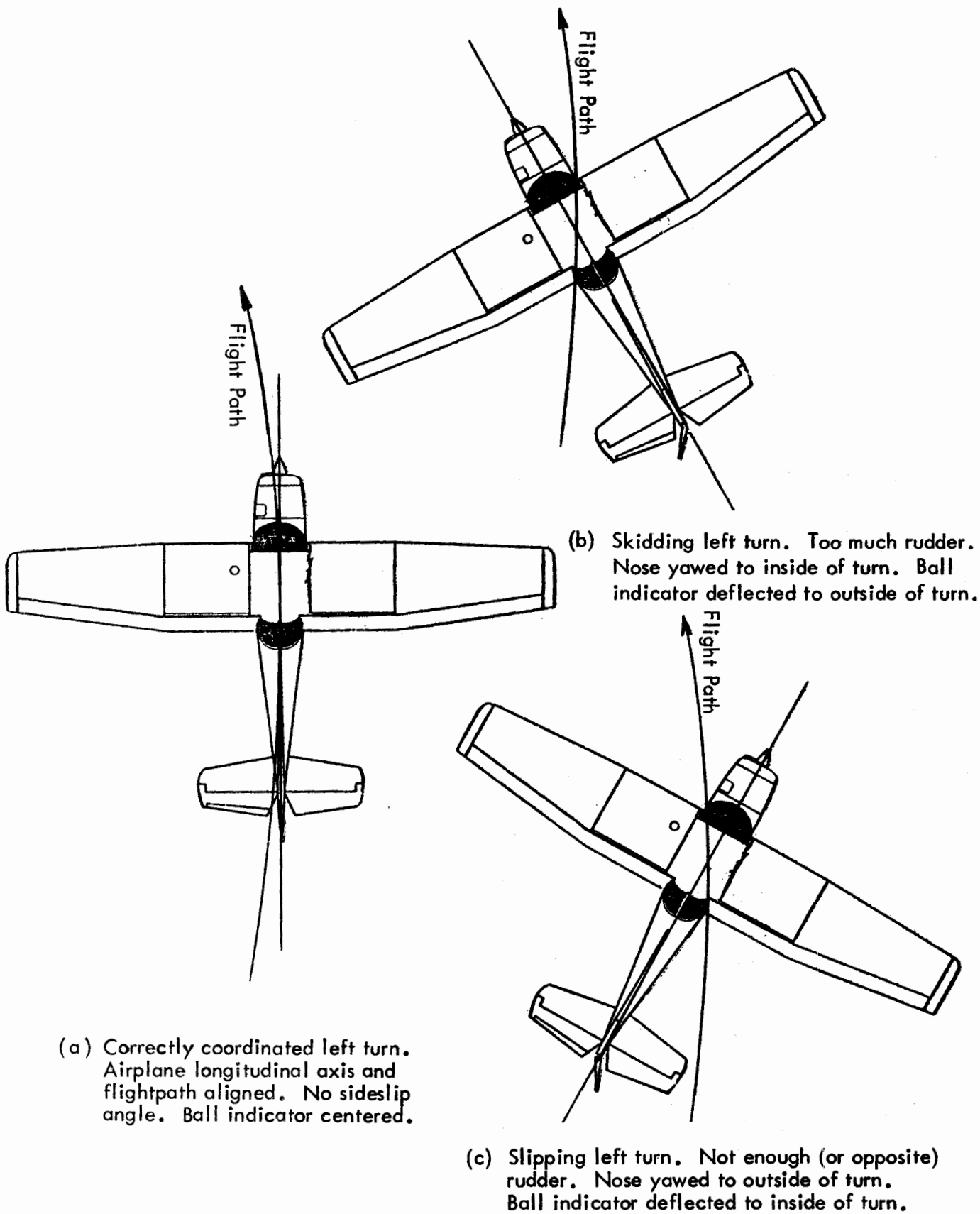

FIGURE A-4. CORRECTLY COORDINATED, SKIDDING AND SLIPPING LEFT TURNS.

is applied. This causes the nose to yaw to the inside of the turn. The relative wind now comes from the outside of the turn and is inclined at an angle to the longitudinal axis. This is a skidding turn, and the ball indicator is deflected to the outside of the turn. Figure A-4(c) shows the airplane in a turn of the same bank angle, but with too little rudder to produce a coordinated turn. The nose is thus yawed to the outside of the turn and the relative wind comes from the inside of the turn. This is a slipping turn, and the ball indicator is deflected to the inside of the turn. If the airplane is stalled during an uncoordinated turn, there is a much more pronounced tendency to spin than if the turn is coordinated. It tends to spin in the direction of the applied rudder, regardless of the bank angle. Thus a stall in a skidding turn causes the inside wing to drop and a spin in the direction of the turn or "out the bottom." A stall in a slipping turn causes the outside wing to drop and spin in the direction opposite to that of the turn.

Despite the fact that all pilots receive this training in stalls and are tested for proficiency in stall recognition and recovery, stall/spin accidents continue to occur with alarming regularity. This is because there is a marked contrast between a student's reaction to stalls practiced in the training environment and to those which occur in other flight phases under more critical conditions such as an engine failure. This is particularly true during landing or takeoff, when the elements of surprise, very low altitude, problem recognition, etc., all call for a high degree of proficiency if an accident involving serious injury is to be avoided. Stall training, for obvious safety reasons, is conducted at high altitudes where most of the pilot's conscious attention is directed toward performance of the stall itself and little or no sense of urgency exists. There is ample opportunity for him to detect the incipient stall characteristics, coordinate and control the performance of the airplane, and make an almost immediate recovery at the appropriate time. Such practice stalls are likely to be entered very

gradually with the airplane flight controls properly coordinated. This usually results in gentle stalls from which recovery may be made promptly; however, it is not representative of the poor control coordination and rapid deceleration likely to aggravate an unintentional stall. These factors cause a much more sudden, abrupt, and full stall that is far more likely to lead to a spin, especially since the pilot is not anticipating the stall or the need to apply recovery control. Although the intent of stall training is to develop an automatic reaction to avoid the stall, the accident record mutely evidences the fact that additional training and education is needed in respect to situational judgments and techniques in various takeoff and landing environments.

SPIN TRAINING

Although most aircraft currently being manufactured are characteristically capable of spinning, there is no current certification requirement for pilot applicants, except for those applying for the flight instructor rating, to demonstrate or to have demonstrated that they possess any practical proficiency relative to spins. Such a requirement was deleted from pilot certification criteria in accordance with CAR Amendment 20-3, adopted June 15, 1949, which stated in part:

"This amendment eliminates spins from the pilot certification requirements and, in lieu thereof, provides for dual flight instruction in the prevention of and recovery from power-on and power-off stalls entered from all normally anticipated flight attitudes. It is believed that the deletion of the spin requirement and the placing of greater emphasis upon the prevention of and recovery from stalls will result in greater air safety in two ways: (a) it will emphasize recognition of and recovery from stalls which, on the basis of available accident statistics, has proved to be the most dangerous maneuver to pilots; and (b) elimination of the required spin maneuver will act as an incentive for manufacturers to build, and operators of schools to use, spin-resistant or spin-proof aircraft."

A comparison of statistics over the years would appear to indicate that emphasizing the recognition of stalls has had a significant effect in reducing their relative numbers. For the 4-year period preceding the amendment, 1945 through 1948, for example, stall/spin accidents accounted for about 48 percent of all fatal accidents. For the 4-year period 1965 through 1968, they accounted for about 27 percent of all fatal accidents.

Although the performance of spins is currently required only for a flight instructor certificate with an airplane or glider instructor rating, many flight instructors introduce spins to their students as a safety precaution, and as a confidence builder.

Fear of and aversion to spins is deeply rooted in the public mind, and many students have an unconscious aversion to them. If one learns the causes of spins and the ease with which normal spins can be induced and stopped, mental anxiety and many causes of unintentional spin accidents may be removed.

A spin may be defined as an aggravated stall that results in autorotation. The airplane describes a corkscrew path in a downward direction. The wings are producing some lift, and the airplane is forced downward by gravity, rolling and yawing in a spiral path.

It has been estimated that there are actually several hundred factors contributory to spinning. From this it is evident that, whether or not spinning is a desirable maneuver or characteristic, it will be a feature of airplanes for some time to come and must be reckoned with in the training of a pilot.

The characteristics of modern airplanes, with regard to spins, have been greatly improved with reference to the amount of speed loss and abuse of controls they will stand. However, all aircraft are a compromise of characteristics designed to produce certain performance. Other characteristics must be sacrificed to produce the desired result. Non-spinnable airplanes are being produced and fly very well. However, the design of such an airplane requires that other desirable characteristics be subordinated to this one particular feature.

In practicing spins, the airplane should be taken first to a safe altitude, never less than 3,000 feet, and a power-off stall executed. The stick should be held as far back and as firmly in this position as possible. As, or just before, the nose starts to fall, when the stall is complete, full rudder should be applied in the direction in which the spin is desired and held there firmly. The ailerons should not be used. The airplane will then begin to rotate in the direction of the applied rudder.

In most light planes, great care must be taken in the proper handling of the throttle in spins. Due to rapid cooling of small engines, and the fact that a hot engine operating at full power may load up and quit when the throttle is suddenly closed, many forced landings have resulted from spin practice.

Carburetor heat has been found to be a great help in keeping an engine ready for use following a spin, just as it is in a prolonged glide. To be fully effective, this heat should be applied before the throttle is closed, in order to warm up the carburetor and intake system. These parts will hold heat longer than the thin exhaust pipes, and warming them in advance will continue its effectiveness for a longer period.

In all cases, the throttle should be closed slowly and smoothly, and the pilot should observe that the engine continues to idle evenly, without popping back or loading.

In some light airplanes it is advisable to continue a certain amount of power throughout the spin entry. This serves two purposes: first, it helps to establish spin rotation upon entry by providing blast on the rudder, and second, it helps keep the engine running smoothly during the transition from normal power to idling. In some airplanes, which are otherwise difficult to spin, a strong blast of the throttle will serve the first purpose and will prevent an unintentional spiral developing in place of a spin. When such a blast is used, care must be taken to see that it is of short enough duration not to bring the airspeed above stalling, and that the throttle is closed during the ensuing spin, since a power spin is considered too violent a maneuver for light airplanes.

The airplane must be completely stalled, otherwise it may not spin and the result will be a skidding spiral of increasing speed. If such a maneuver results, it is useless to continue it in the hope of eventually spinning. The only proper procedure in such an instance is to recover and start over from a proper stall. Many modern airplanes have to be forced to spin and require considerable judgment and technique to get them started. Paradoxical as it may seem, these same airplanes that have to be forced to spin may be accidentally put into a spin by mishandling in turns and slow flight. This fact is additional evidence of the necessity for the practice of stalls until the ability to recognize them is developed.

Recovery from a spin is quite simple. When recovery from a spin is desired, the rotation is slowed by applying full rudder pressure opposite the direction of rotation. As the rotation slows, the stall is broken by briskly moving the elevator control forward or allowing it to move forward, whichever is necessary in the airplane used. The rudder pedals should be neutralized as the rotation stops. From this point in the resulting dive, the recovery is identical with the standard stall recovery described in the preceding section. During spin recoveries in light planes, the elevator control

should not be held forward after the stall is broken or negative "G's" will be experienced and airspeed may become excessive. During spin recoveries in heavier airplanes, it will usually be longer before the airplane responds to the control actions used for the recovery.

Spins should be practiced both to the right and to the left, and all control movements should be positive. Airplanes vary considerably in their spin characteristics in right and left spins. This is usually due to differences in rigging to take care of torque, as well as to the effect of the torque itself.

The effect of the use of ailerons, either with or against the rotation during spins, has been the subject of much research and apparently follows no set rule for all airplanes. The theory and results in actual practice are quite involved. It is therefore important that spins are done with the use of the elevators and rudder only, since ailerons either with or against the spin may increase the rotation rate and delay recovery. There must be no tendency to use ailerons, particularly in a cross-control manner.

Although intentional spins are usually done from straight stalls, as mentioned earlier, unintentional spins can result from improperly coordinated turns, both as a result of the nose being carried too high and from pulling the turn too tight.

Although they may be demonstrated by an instructor, they should not be practiced by the student, since the entry is likely to be much more rapid and disorienting. They are to be demonstrated only for the purpose of showing the results of misapplication of the controls, and pitfalls to avoid.

Any tendency to relax on the controls after the spin is in progress result in a sloppy spin and in many cases will completely stop the spin and allow a sloppy spiral

to replace it. The student must hold his controls firmly in full spin position until recovery is desired and then move them positively, or allow them to move for the recovery.

During instruction in unintentional spins, no definite spin entry technique is used since the primary purpose is the development of familiarity and trained reaction for use in recovery from an accidental spin. It is obvious that any accidental spin will not be the result of a trained entry technique.

The most important point is that all spins are the result of allowing a stall to develop. The ability to detect promptly the loss of speed which results in such a stall, and to correct it in time, will prevent the spin.

It is also important to note and appreciate the loss of altitude during the approach to the stall, in the stall which precedes the spin, as well as in the spin itself.

The situation can easily become critical during a spin in an airplane which is not loaded properly. Any deviation from the weight and balance limitations as specified in the placard or Airplane Flight Manual for the plane must not be allowed. It is important that loading of any plane to be used for spins is in accordance with specifications and that the load distribution is within limits. It is particularly important that the baggage compartments, usually in the rear of the airplane, not be overloaded.

Should any airplane, during a spin, develop back pressure on the stick (that is, the stick tends to stay back of its own accord when released, or requires any unusual pressure when attempts are made to return it to neutral), it should be removed from spin use until the trouble is located. Such a condition is very apt to cause the

plane to develop bad spin characteristics, particularly in a spin of over two or three turns duration. No student should indulge in prolonged spins in any airplane, and no spins of more than six turns should be made even in approved airplanes, since they are not tested beyond these limits.

SECTION 7

SPIN TESTING AND CERTIFICATION OF AIRCRAFT

When CAR Amendment 20-3 was adopted in 1949, it was felt that the deletion of mandatory spin training for pilot certification would "act as an incentive for manufacturers to build, and operators of schools to use, spin resistant or spin-proof aircraft." In fact, the expected development of spin resistant or spin-proof aircraft has not materialized.

On the contrary, the trend toward modern-day, high-performance aircraft has resulted in spin characteristics considerably less favorable than those associated with predecessor aircraft. Spin characteristics have generally been compromised to permit operation with large fuel and passenger loads over a wide fore/aft range of center of gravity locations. Early airworthiness requirements provided that all airplanes under 4000 lbs. recover from a 6-turn spin within 1-1/2 additional turns, at all certificated center of gravity positions, simply by releasing the flight controls.

As the new generation of aircraft developed, compliance with the older, more stringent spin-recovery requirements became increasingly difficult. Present regulations as set forth in FAR 23.221 include the following:

"23.221 Spinning.

- (a) Normal category. A single engine, normal category airplane must be able to recover from a one-turn spin or a 3-second spin, whichever takes longer, in not more than one additional turn, with the controls used in the manner normally used for recovery. In addition -
- (1) For both the flaps-retracted and flaps-extended conditions, the applicable airspeed limit and positive limit maneuvering load factor may not be exceeded;
 - (2) There may be no excessive back pressure during the spin recovery; and

- (3) It must be impossible to obtain uncontrollable spins with any use of the controls. For the flaps-extended condition, the flaps may be retracted during recovery.
- (b) Utility category. A utility category airplane must meet the requirements of paragraph (a) of this section or the requirements of paragraph (c) of this section.
- (c) Acrobatic category. An acrobatic category airplane must meet the following requirements.
 - (1) The airplane must recover from any point in a spin, in not more than one and one-half additional turns after normal recovery application of the controls. Prior to normal recovery application of the controls, the spin test must proceed for six turns or 3 seconds, whichever takes longer, with flaps retracted, and one turn or 3 seconds, whichever takes longer, with flaps extended. However, beyond 3 seconds, the spin may be discontinued when spiral characteristics appear with flaps retracted.
 - (2) For both the flaps-retracted and flaps-extended conditions, the applicable airspeed limit and positive limit maneuvering load factor may not be exceeded. For the flaps-extended condition, the flaps may be retracted during recovery, if a placard is installed prohibiting intentional spins with flaps extended.
 - (3) It must be impossible to obtain uncontrollable spins with any use of the controls."

Thus, type certification spin tests for airplanes certificated in the normal category have been eliminated for all practical purposes. An excerpt from FAA Advisory Circular 23-1, "Type Certification Spin Test Procedures," for example, states the following:

"A basic concept of type certification flight testing is to explore an envelope of the airplane's characteristics which is greater in all areas than the intended operational envelope. This

is to assure that, during normal operations, the operational pilot will not encounter any airplane characteristic that has not been explored by an experienced test pilot. With regard to the spinning requirements in CAR 3, type certification testing requires recovery capability from a one-turn spin while operating limitations prohibit intentional spins. This one-turn margin of safety is designed to provide adequate controllability when recovery from a stall is delayed.

"The spin requirements for normal category airplanes have changed over the years from six turns with a free control recovery to the present one-turn spin with a normal control movement recovery. Originally, and during the changes, there has never been any reference to the manner in which the spin entry should be conducted. The preamble of Amendment 3-7, dated May 3, 1962, states in part, 'These [one-turn spin] tests are considered to be an investigation of the airplane's characteristics in a delayed stall, rather than true spin tests.' This statement is significant and recognizes that CAR 3.124(a) does not require investigation of the controllability in a true spinning condition for a normal category airplane. Essentially, the test is a check of the controllability in a delayed recovery from a stall. Intentional and inadvertent, normal and accelerated stalls should be considered."

FAA Advisory Circular, "Hazards Associated with Spins in Airplanes Prohibited from Intentional Spinning," AC61-67, dated February 1, 1974, provides further amplification on these regulations. This advisory circular has been published to:

- a. Inform pilots of the airworthiness standards for the type certification of small airplanes prescribed in Section 23.221 of the Federal Aviation Regulations (FARs) concerning spin maneuvers;
- b. Emphasize the importance of observing restrictions which prohibit the intentional spinning of certain airplanes;

- c. Recommend specific flight operations procedures to reduce the probability of entering an inadvertent spin during the performance of stall entries and recoveries; and
- d. Reduce the number of airplane accidents resulting from spins.

It states that:

- a. There has been an alarmingly high number of accidents resulting from failure to recover from either intentional or inadvertent spins in airplanes placarded against intentional spins. Nearly 45 percent of all FATAL accidents in small airplanes have been attributed to stall/spin causes.
- b. We have determined that some private and commercial pilots as well as some flight instructors are misinformed about the reasons for operating restrictions against spins.

Operating limitations are imposed (on normal, utility, and acrobatic category aircraft) for the safety of the pilot and his passengers, and operations contrary to these restrictions are a serious compromise of safety. It is, therefore, most important that all pilots, flight and ground instructors, and pilot examiners apply the following information to pilot training and flight operations.

Since airplanes certificated under these (normal category) rules have not been tested for more than a one-turn or three-second spin, their performance characteristics beyond these limits are unknown. THIS IS WHY THEY ARE PLACARDED AGAINST INTENTIONAL SPINS.

Similarly, since airplanes certificated under these (acrobatic category) rules have not been tested for more than six turns or three seconds, their performance characteristics beyond these limits are unknown. THE PILOT OF AN AIRPLANE PLACARDED AGAINST INTENTIONAL SPINS SHOULD ASSUME THAT THE AIRPLANE MAY BECOME UNCONTROLLABLE IN A SPIN.

This is particularly important in the case of aircraft certificated in the normal category at gross weight and in the utility category at reduced operating weight. When operated in the utility category, these aircraft may meet the acrobatic spin requirement, and thus are safe for intentional spins. However, when operated in the normal category, at gross weight, intentional spins are prohibited since only a one turn spin test has been performed at this weight and center of gravity position. Performance of spins in airplanes placarded against intentional spins is flirting with unknown recovery characteristics. Certain of these airplanes have been proven by operational experience to have unsafe characteristics in sustained spins.

The advisory circular further recommends that:

"Stall demonstrations and practice are a means for a pilot to acquire the skills to recognize when a stall is about to occur and to RECOVER as soon as the first signs of a stall are evident. IF A STALL DOES NOT OCCUR - A SPIN CANNOT OCCUR. It is important to remember, however, that a stall can occur in any flight ATTITUDE at any AIRSPEED, if controls are misused.

- (1) Power Stalls should be entered with approximately 65 percent power. Stalls in airplanes with relatively low power loadings using maximum climb power result in an excessive angle of attack making the recovery more difficult.
- (2) Simulated Takeoff and Departure Stalls should be entered at liftoff speed, with the gear extended and flaps in takeoff configuration. In spite of Flight Test Guide instructions to the contrary, many flight test applicants continue to attempt these stalls from cruising speed in clean configurations. The objective of this maneuver is to simulate the flight situation which exists immediately after takeoff.
- (3) Stall Recoveries should be initiated as soon as evidence of a stall is detected. Such evidence may be uncontrollable pitching, buffeting, and a rapid decay of control effectiveness."

Thus, the turnabout in projected design trends, coupled with deletion of the spin training requirement, results in a situation in which aircraft characteristically capable of spinning are being flown by pilots with no training or experience in spins or spin recovery procedures.

It then becomes pertinent to ask what approaches may be taken with regard to upgraded flight training or revised airplane certification standards. One or both of these could be expected to have a favorable effect on the stall/spin accident rate.

SECTION 8
AERODYNAMICS

I. ANGLE OF ATTACK, LIFT AND DRAG

The best understanding of why an airplane can spin and how it behaves in flight at slow airspeeds is obtained by looking at some principles of aerodynamics which are not presented in typical civilian pilot training courses. A review of appropriate terminology is presented first.

Airfoil Terminology

Aircraft are designed to fly through the air; to accomplish this efficiently they must possess an appropriate aerodynamic shape. The terms which apply to those shapes (in particular, airfoils) are defined and discussed below (see Figure A-5).

1. **MEAN CAMBER LINE:** The line formed by connecting the locus of points equidistant from the upper and lower surfaces of an airfoil.
2. **CHORD:** The straight line distance between the leading and trailing edges of an airfoil. Chord is denoted by the letter "c".
3. **CHORDLINE:** The straight line which forms the chord.
4. **ANGLE OF INCIDENCE** (not shown in Figure A-5): The angle of incidence is the angle formed by the chordline of the wing and the longitudinal axis of the aircraft. This angle merely describes the orientation of the wing on the fuselage. Notice in Figure A-5 that two different types of airfoils are shown. The upper airfoil is said to have "positive" camber. This means that the mean camber line falls above the chordline. If this line fell below the chordline, it would be called "negative" camber. The lower airfoil has its mean camber line coincident with the chordline. This type of airfoil is called a symmetric airfoil because it is symmetrical with respect to the chordline.
5. **FLIGHT PATH:** The line which traces the direction of travel of the aircraft through the air mass. This is usually interpreted to mean the line traced by the center of gravity of the aircraft. Flight path angle is the angle between the horizontal and the flight path, denoted by the Greek letter gamma (γ).

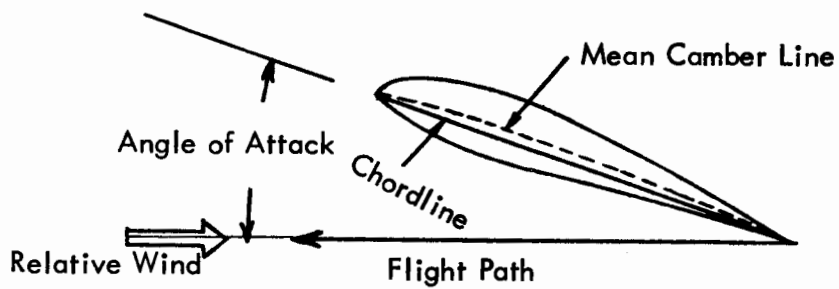

(a) Cambered Airfoil

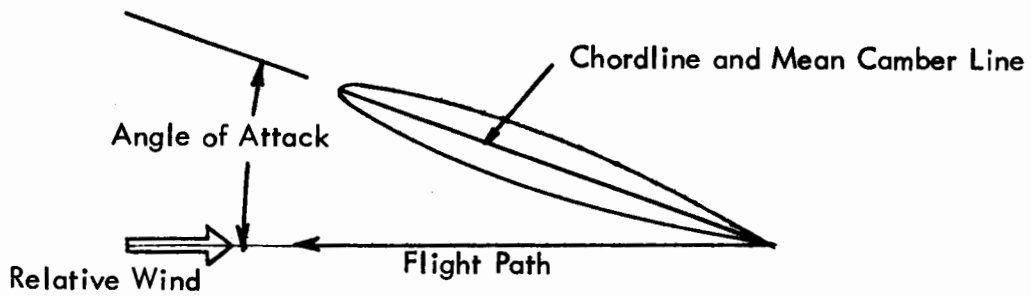

(b) Symmetrical Airfoil

FIGURE A-5. AIRFOIL TERMINOLOGY.

6. **RELATIVE WIND:** Relative wind refers to the direction of travel and the speed of the air which is approaching the aircraft. The relative wind (RW) is equal in magnitude and opposite in direction to the velocity of the aircraft (or airfoil). Do not confuse relative wind with wind. The latter term is in reference to air mass movement relative to the ground, while the former term refers to the movement of an aircraft within an air mass.
7. **ANGLE OF ATTACK:** Angle of attack denoted by the Greek letter alpha (α), is the angle formed by the direction of the relative wind (or the flight path), and chordline of the airfoil.
8. **CRITICAL ANGLE OF ATTACK:** That angle of attack at which a wing or airfoil section stalls. A wing will stall when it is operated in excess of this angle of attack, regardless of its airspeed.
9. **PITCH ATTITUDE:** The angle between the horizontal and the aircraft longitudinal axis, denoted by the Greek letter theta (θ).
10. **DYNAMIC PRESSURE:** The pressure, denoted by the letter q , caused by airflow impacting on an aircraft. It increases with air density and as the square of the airspeed (V^2). $q = 1/2 \rho V^2$.
11. **LIFT & DRAG COEFFICIENTS:** Dimensionless parameters which describe how lift and drag vary with angle of attack. The overall lift and drag on a wing or airplane may be computed from the formulas

$$L = C_L q S \quad \text{and} \quad D = C_D q S,$$

where S is the reference (wing) area.

12. **AIRCRAFT AXES - ROLL, YAW AND PITCH:** All motion of the aircraft takes place about the center of gravity, and when this motion is broken down into yaw, pitch or roll, it is seen that each takes place about a particular axis of the aircraft (vertical axis, lateral axis, or longitudinal axis). Each motion, and its associated axis, is depicted in Figure A-6. Yaw is a sideways movement of the nose. It is a rotation about the vertical axis and is produced (or controlled) by the rudder. An airplane is said to be in a yawed condition when the relative wind, as seen from above, is not aligned with the longitudinal axis. In this case, it is said to be operating with an angle of sideslip. Pitch is a vertical movement of the nose. It is a rotation about the lateral axis and is produced by the elevator. Roll is a rotation of the aircraft about the longitudinal axis. Roll is produced by the ailerons.

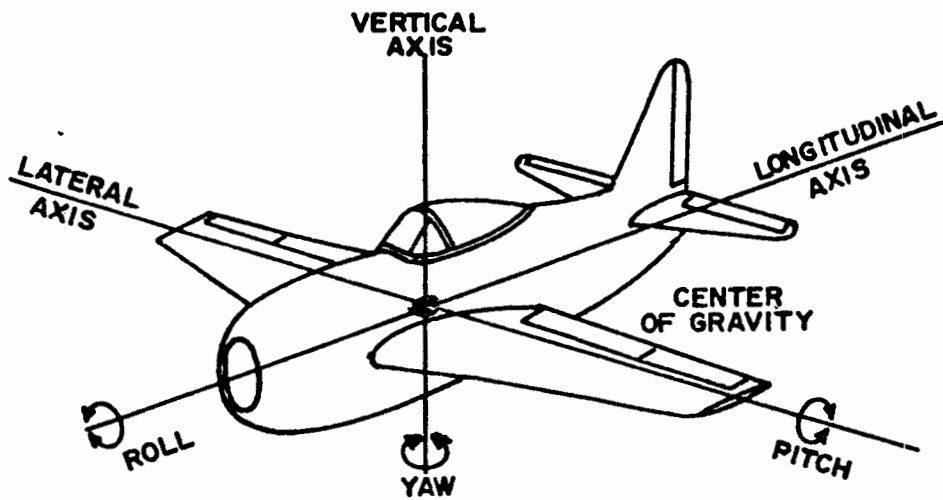

FIGURE A-6. AIRCRAFT AXES AND MOTIONS.

13. **MOMENT:** A combination of forces (acting at a distance from an axis) tending to produce rotation of an aircraft about one of its axes. Moments may be rolling, yawing or pitching moments. Rolling moments are produced by ailerons, yawing moments by rudder, and pitching moments by elevators, flaps, and power.

It is important to correctly differentiate between pitch attitude, angle of attack and flight path angle. Figures A-7, A-8 and A-9 show these angles (exaggerated for clarity) for an aircraft in steady level flight, climb and descent. These figures are shown for an airspeed of 100 mph, so the angle of attack is the same (5°) in each case. Figure A-10 also shows the same aircraft in level flight at 70 mph. This flight condition, of course, requires a higher angle of attack (10.2°) to produce enough lift to sustain the airplane at the reduced speed, and cause the flight path to be level. Recall now that a wing stalls when its critical angle of attack is exceeded, regardless of aircraft attitude. Usually this occurs in a nose up pitch attitude similar to that in Figure A-10. However, Figure A-11 shows how this may occur even at high airspeed with the pitch attitude very nose low, in a too rapid pullout from a dive. In this figure, the elevators have been brought aft to raise the nose, resulting in an angle of attack of 20° . If the wing on the illustrated aircraft is assumed to stall at 18° , this aircraft is stalled, and the elevators must be pushed forward to reduce the angle of attack to avoid a prolonged stall or a spin.

A more detailed discussion of lift and drag is presented next, to better understand the principles of slow speed flight, stalls and spins.

LIFT. Lift is the force which "lifts" an aircraft. Ordinarily, one thinks of lift as acting in a direction opposite the weight of the aircraft, but this is not always the case. Lift is the force generated perpendicular to the relative wind. In straight and level flight (constant speed, constant direction, constant altitude), this force is just about equal in magnitude and opposite in direction to weight. In any

- α = Angle of Attack
- γ = Flight Path Angle
- θ = Pitch Attitude

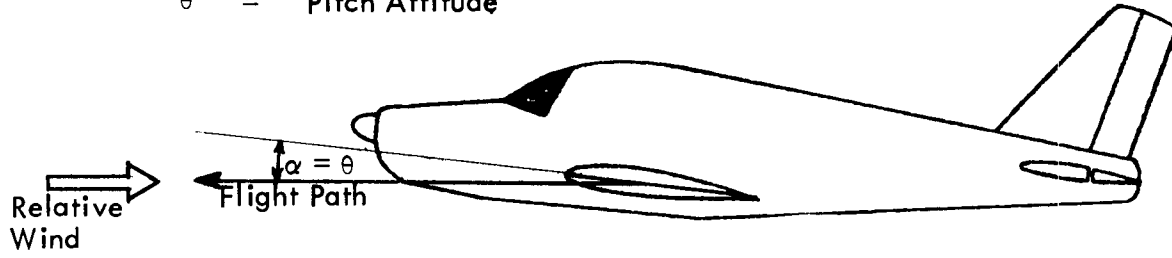

FIGURE A-7. LEVEL FLIGHT - 100 MPH.

$$\alpha = 5^{\circ} \quad \theta = 5^{\circ} \quad \gamma = 0^{\circ}$$

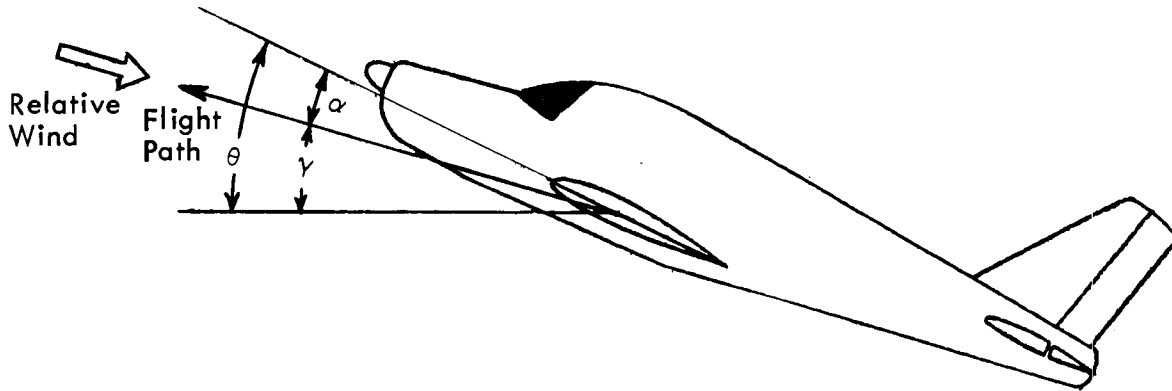

FIGURE A-8. CLIMB - 100 MPH.

$$\alpha = 5^{\circ} \quad \theta = 13^{\circ} \quad \gamma = 8^{\circ}$$

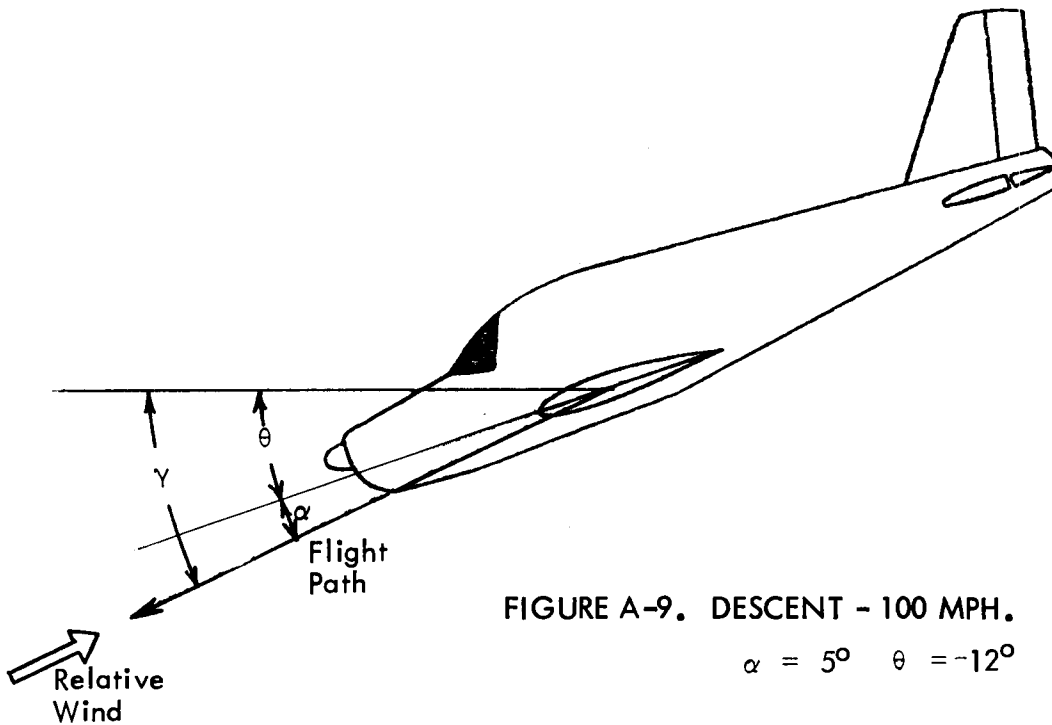

FIGURE A-9. DESCENT - 100 MPH.

$$\alpha = 5^{\circ} \quad \theta = -12^{\circ} \quad \gamma = -17^{\circ}$$



(a) Level Flight at 100 mph
 $\alpha = 5^\circ$
 Elevator Neutral



(b) Level Flight at 70 mph
 $\alpha = 10.2^\circ$
 Elevator Deflected
 Partially Nose-Up

FIGURE A-10. AIRCRAFT IN LEVEL FLIGHT.

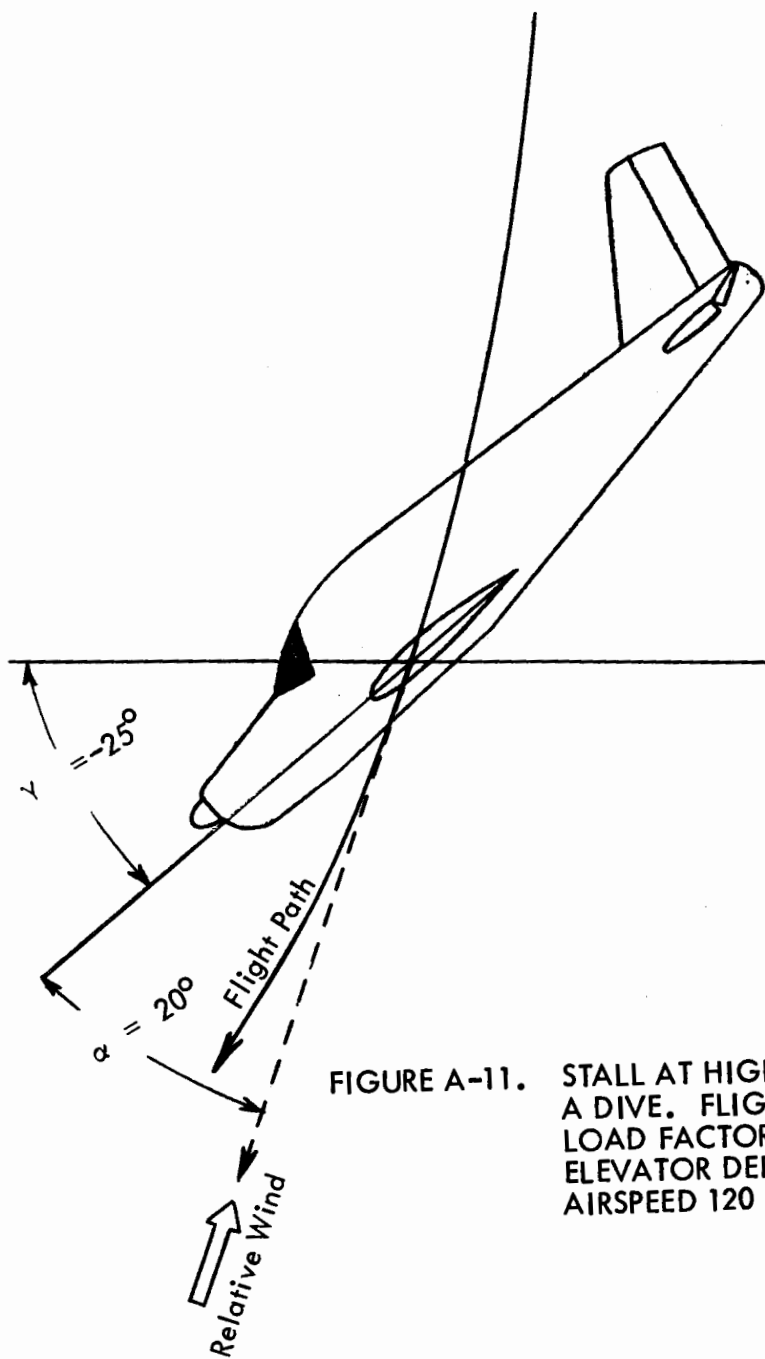

FIGURE A-11. STALL AT HIGH AIRSPEED IN PULLOUT FROM A DIVE. FLIGHT PATH IS CURVED DUE TO LOAD FACTOR. $\alpha = 20^\circ$. FULL NOSE-UP ELEVATOR DEFLECTION CAUSES STALL. AIRSPEED 120 MPH.

other maneuver both the magnitude and the direction of lift can differ considerably from the weight of the aircraft. For example, consider an aircraft in a loop. What is the direction of lift during the loop? As indicated in Figure A-12, the lift is acting perpendicular to the relative wind; that is, it is directed toward the center of the loop.

Now that lift is defined, those factors which contribute to its magnitude must be considered. Lift, as indicated above, is a force, and any force can be expressed as the product of a pressure acting on a surface area. The dynamic pressure (q) acting on the surface area of the wing (S) produces lift. Written in equation form:

$$L = C_L q S$$

The factor C_L is a proportionality constant which for a particular wing varies only with angle of attack (α). This factor is called the coefficient of lift. The coefficient of lift is a function of angle of attack and the camber of a particular airfoil.

Before examining the factors which determine how much lift is produced under a given set of circumstances, it is important to have an idea of how the coefficient of lift accounts for changes in camber and angle of attack. As it turns out, the value of C_L for a given airfoil is dependent solely upon the angle of attack (this statement assumes an incompressible, non-viscous, ideal atmosphere, and an airfoil of fixed camber). Wind tunnel tests are used to determine the value of the coefficient of lift as a function of angle of attack. If an airplane model were placed in a wind tunnel and its lift at various angles of attack measured, the values of lift coefficient versus angle of attack would plot as in Figure A-13, irrespective of the airspeed in the tunnel. The curve thus obtained would be almost identical to that which would be measured on the full scale airplane in flight.

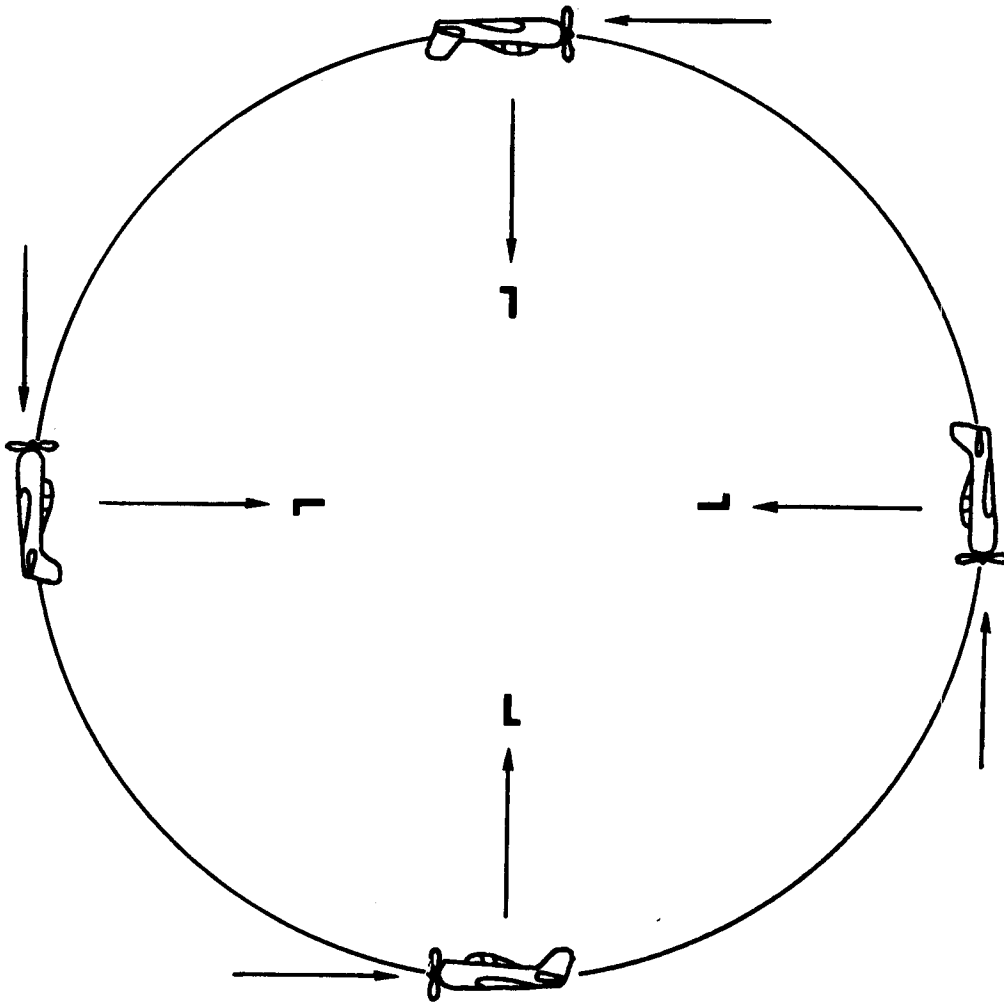

FIGURE A-12. LIFT AND RELATIVE WIND IN A LOOP.
LIFT ACTS PERPENDICULAR TO THE
RELATIVE WIND.

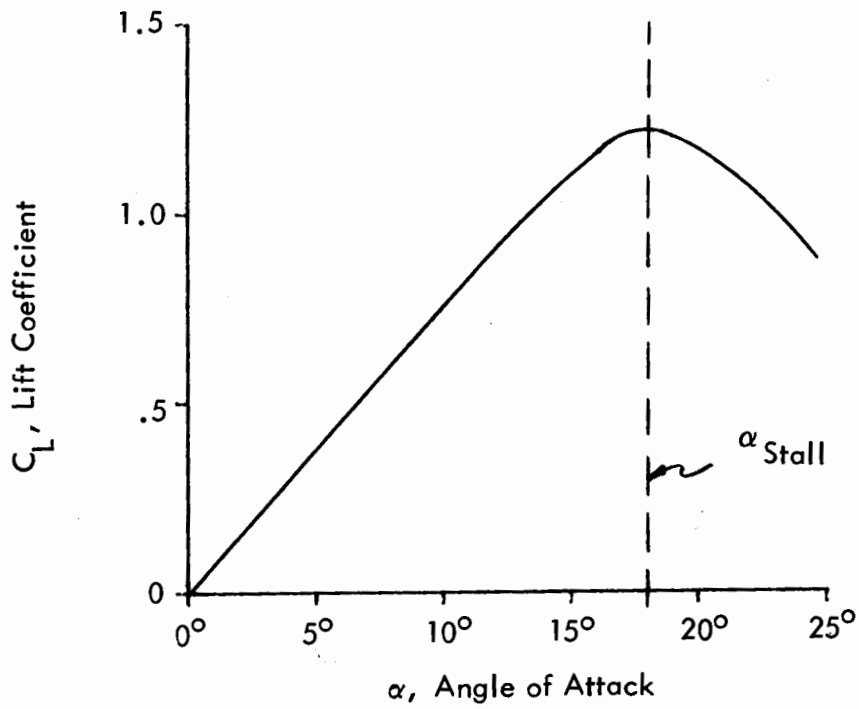

FIGURE A-13. LIFT COEFFICIENT VS. ANGLE OF ATTACK.

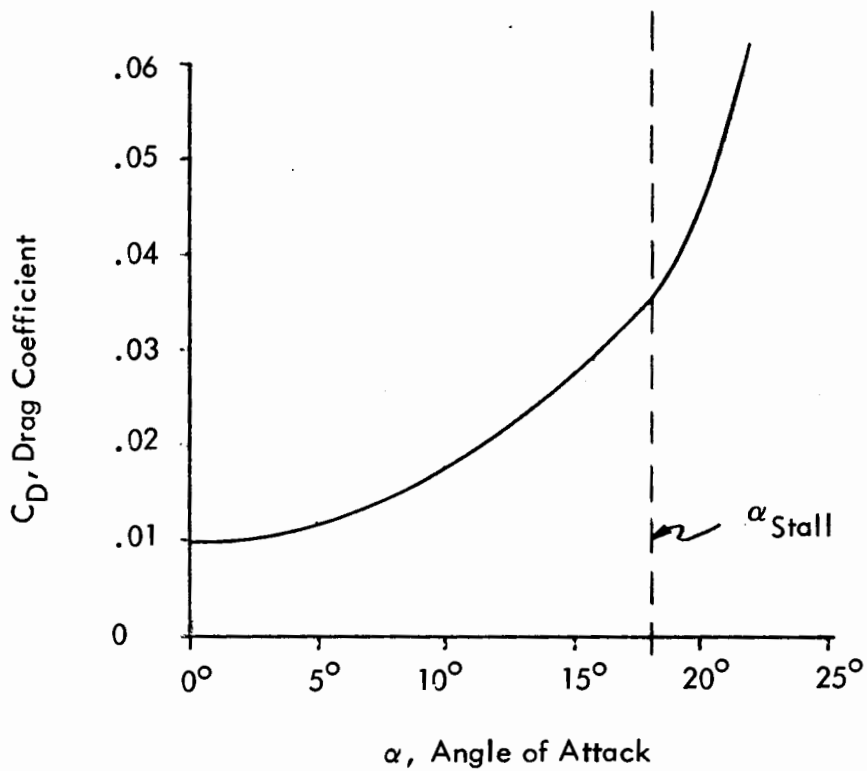

FIGURE A-14. DRAG COEFFICIENT VS. ANGLE OF ATTACK.

The slope of the curve is determined by the shape of the airfoil (camber), and the angle of attack determines the value of the coefficient of lift. As shown on Figure A-13, an angle of attack of 10° yields a coefficient of lift of 0.75. These numbers are used purely for illustrative purposes and should not be construed as fixed values. Different types of airfoils have C_L curves of different shapes, but the illustration of Figure A-13 is typical. Again for a particular wing or aircraft, the coefficient of lift is dependent only upon the angle of attack.

Now consider the lift developed by a wing in terms of the lift equation: the wing area is fixed in a given aircraft configuration. Also, the camber of this wing is fixed. With these constraints in effect, it is readily apparent that the only quantities which can affect lift are q and C_L . Lift may thus be increased by increasing either the dynamic pressure (increase true airspeed or density) or the coefficient of lift (increase angle of attack). Another way of looking at this is, since dynamic pressure is directly proportional to true airspeed squared and the density ratio, a decrease in either one of these quantities decreases q , and therefore, lift also decreases. To remain in level flight an aircraft must generate an upward force (lift) equal to the downward force (weight). As speed increases, the weight of the aircraft stays the same (neglecting fuel consumed), so the lift generated by the wings must stay the same. Since dynamic pressure has increased with the increase in speed, something must be decreased to compensate. This "something" is the coefficient of lift, and its value is reduced by decreasing the angle of attack (move the stick forward).

On the other hand, consider slowing down but remaining at the same altitude. Lower airspeed means less dynamic pressure, so something must be increased to keep the lift at a constant value. Once again the thing to be changed is the coefficient

of lift. This can be done by increasing the pitch attitude, which causes an increase in angle of attack, although the flight path itself remains level. The resulting increase in the lift coefficient offsets the decrease in dynamic pressure due to the lowered airspeed, so the lift remains constant and the flight path level. A power adjustment may also be required since the drag also varies with angle of attack and dynamic pressure as explained below.

Notice that the value of C_L increases with increases in angle of attack only up to a point. This point is identified in Figure A-13 as α_{Stall} . An increase in angle of attack beyond α_{Stall} results in a decrease in the value of C_L . This situation, where an increase in α results in a decrease of C_L is referred to as stall. The angle of attack which corresponds to the maximum value of the coefficient of lift is called the stalling angle of attack (α_{Stall}). Since the coefficient of lift is changed only by changes in angle of attack (in a given configuration), a stall must be produced by exceeding the angle of attack which corresponds to C_{Lmax} . Also, since angle of attack is the cause of a stall, an aircraft may be stalled at any altitude, attitude, airspeed, etc., merely by exceeding the angle of attack which corresponds to the maximum value of the coefficient of lift. Notice, also, that when stalled, some lift is still being produced since the coefficient of lift still has some non-zero value. Referring to the C_L curve, notice that once stalled, the value of C_L decreases with further increases in angle of attack but still has some finite value. This means some lift is still there, but not enough to maintain level flight. To recover from a stall you must decrease the angle of attack (forward stick) and the value of C_L will pop right back to a usable value. A stalled aircraft will lose altitude, and, if the aircraft is initially close to the ground, the result is obvious.

DRAG. So far the discussion has been about lift, that force which keeps an aircraft "aloft." Another force of concern is drag (D). Drag is the force which tends to retard motion through the air. The drag force acts in a direction opposite to that of the flight path, that is, in the same direction as the relative wind. The total drag on an airplane is the sum of two drag components, the parasite and the induced drag. Parasite drag is that drag caused by the pressures on the surfaces of the airplane, including wings, tail, fuselage, landing gear, etc., plus the drag caused by friction of the air over the surfaces of the airplane. The induced drag is that component of drag "induced" by the production of lift on the wing. The following discussion describes how drag varies on a given airplane when it is flown over a range of airspeeds and angles of attack.

Since drag, like lift, is a force, it may be expressed as a pressure acting upon a surface area. Again, the pressure (q) acting upon a surface (S) does not fully describe total drag (D). A coefficient must be applied to make the expression for total drag accurate. This factor is called the coefficient of drag and is given the symbol C_D . As with C_L , C_D accounts for the changes in camber and angle of attack of an airfoil, and the curve for any particular aircraft or configuration is determined through wind tunnel testing. Total drag, then, may be expressed as:

$$D = C_D q S$$

A graph of C_D versus α , which is derived from measurements taken in a wind tunnel, is shown in Figure A-14. Notice in the figure that C_D continues to increase with increases in angle of attack, while C_L reaches a maximum value and then falls off rapidly. The relationship of C_L to C_D and how each varies with angle of attack becomes very important when spins are discussed.

II. SPINS

Now that stalls, lift and drag have been discussed, spins can be considered. A spin, by definition, is an aggravated stall which results in autorotation. Spins may be thoroughly examined through a detailed consideration of that definition.

First, consider an airplane cruising in straight and level flight at 5° angle of attack, well below stalling. The values of lift and drag coefficients at which the wings are operating are shown in Figure A-15. Now assume that a gust causes the airplane to begin to roll. Figure A-16 shows that because of this rolling velocity, the downgoing wing experiences an upward directed increment in relative wind which tends to increase its angle of attack (say to 6°). The reverse is true on the upgoing wing, where the angle of attack may be decreased (say to 4°). These changes in angle of attack are such as to cause increased lift on the downgoing wing and decreased lift on the upgoing wing. Thus, the tendency to continue rolling is prevented by the change in angle of attack on each of the wings. Thus, the airplane is stable with respect to disturbances in rolling velocity.

Now consider the same airplane, but assume it has just stalled and is now at an angle of attack of 20° . Also assume that at the instant of the stall, the aircraft develops a rolling velocity. As before, the downgoing wing experiences an increase in angle of attack and the upgoing wing a decrease in angle of attack. But now, because both wings are operating in the region beyond stall, the increase in angle of attack (say to 21°) on the downgoing wing corresponds to a reduction in lift coefficient on that wing. Similarly, the decrease in angle of attack on the upgoing wing (say to 19°) corresponds to an increase in lift coefficient on that wing. Thus, the rolling tendency is increased since the lift on the upgoing wing is greater than that on the downgoing wing. Notice that this is just the opposite of the behavior of the wing when it is operating below stalling angle of attack. Thus, a rolling motion experienced at angles of

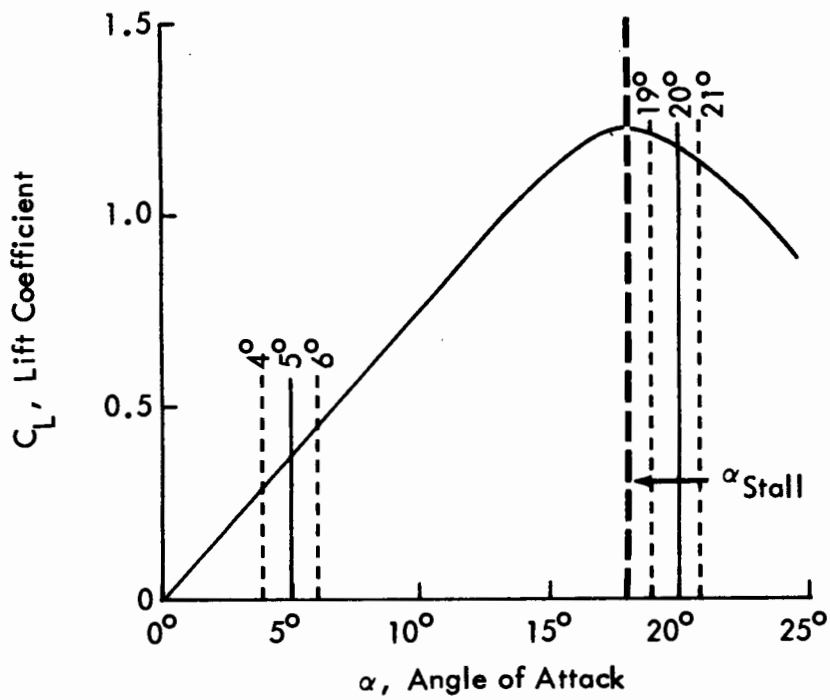

FIGURE A-15(a). LIFT COEFFICIENT VS. ANGLE OF ATTACK.

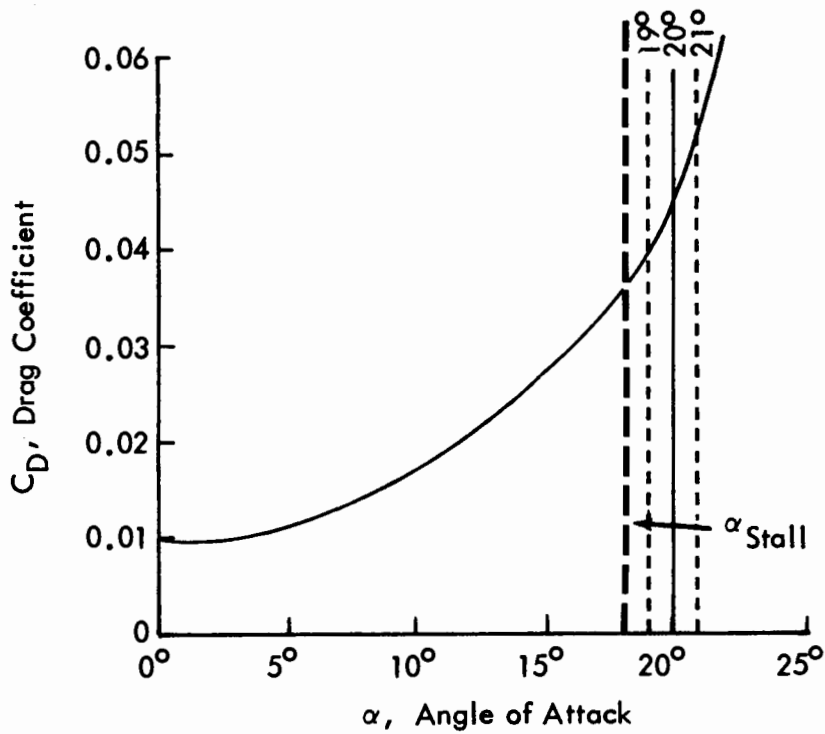

FIGURE A-15(b). DRAG COEFFICIENT VS. ANGLE OF ATTACK.

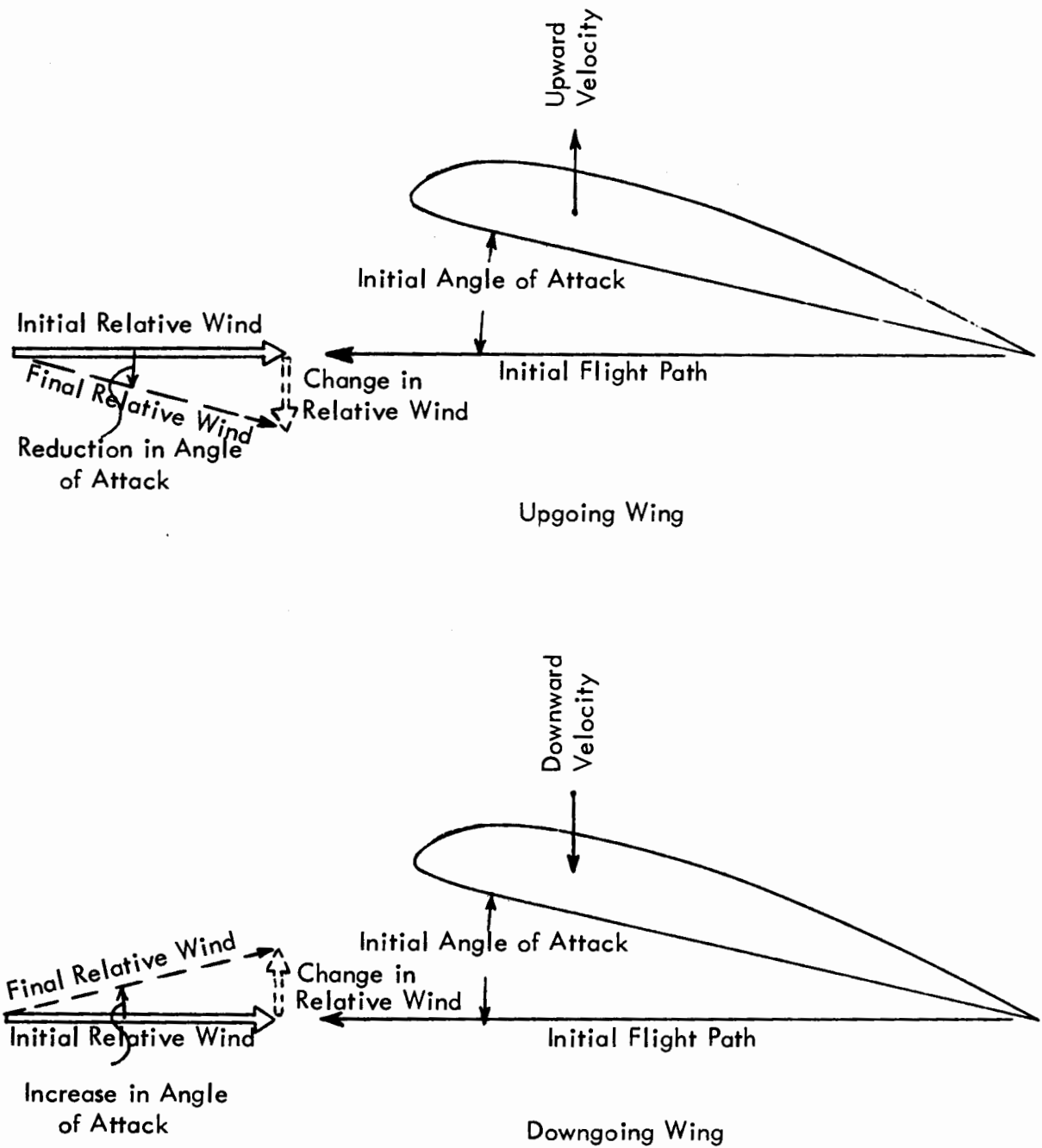

FIGURE A-16. CHANGES IN ANGLE OF ATTACK DUE TO ROLLING VELOCITY.

attack beyond stalling is destabilizing and tends to increase. Now look at the changes in the drag coefficient on each wing due to the aircraft's rolling velocity. The increased angle of attack on the downgoing wing produces increased drag on that wing, while the upgoing wing experiences decreased angle of attack and decreased drag. These drag changes are such as to cause the aircraft to yaw in the direction of the downgoing wing. These rolling and yawing tendencies are exactly what is observed as the aircraft enters a spin, and explain why the spin is self sustaining. In practice, intentional spin entry is conducted by stalling the aircraft and then causing it to yaw with the rudder. As the rudder causes the yaw, it also creates a slight rolling velocity, both of which act to destabilize the airplane and cause it to spin. That is why yaw is the real culprit in spin entries following an unintentional stall. Also, since an unintentional stall is likely to occur with the aircraft in a yawed condition (ball indicator not centered), a spin is more likely to develop than when careful coordination is used as during intentional stall practice.

III. LEFT TURNING TENDENCY

Aircraft engines built in the United States rotate clockwise as viewed from the pilot's seat. As a result, these aircraft exhibit a tendency to turn to the left, particularly when operating at high angle of attack. This left turning tendency is due to three separate causes:

1. Propeller Lift Distribution - When a propeller driven airplane is flown at high angle of attack, the propeller shaft axis is inclined at some angle to the relative wind. This inclination causes the lift distribution to differ on the up and downgoing propeller blades, such that a left yawing moment is produced. In flight at lower angles of attack, where the propeller shaft axis may be almost aligned with the relative wind, this effect is not present.
2. Engine Torque - The propeller rotates clockwise as viewed from the pilot's seat. The torque reaction of the airplane is to rotate in the opposite direction, that is, left wing down, which causes

a left turning tendency and moment. This effect is greatest when the engine is operated at high power, such as during takeoff, climb and practice of slow flight and departure stalls.

3. **Spiral Slipstream** - A propeller sheds a helical wake as it pulls the airplane through the air. When an airplane is operated at high angle of attack, this wake tends to sweep upward along the left side of the fuselage, impacting on the left side of the vertical tail and fuselage. This corresponds to a relative wind from the left side of the vertical fin. Since the fin is operating with an angle of attack, it produces a lift force to the right, causing the aircraft to yaw left. When the aircraft is in flight at cruising airspeeds (low angle of attack), the fin operates in undisturbed air at zero angle of attack, so that no yawing tendency is produced.

The left turning tendency is a major factor with which pilots must contend during normal aircraft operation. It requires that right rudder be applied by the pilot to prevent a left turn during takeoff, climbout and practice of slowflight and departure stalls. Under these conditions, the rudder is generating a right yawing moment to compensate for the left turning tendency produced by the propeller, engine torque, and spiral slipstream.

The ball indicator is the instrument which tells the pilot if he is using the correct amount of right rudder. Coordinated flight (including turns) is indicated with the ball in center. (It should be pointed out that the deflection of the ball indicator is proportional to forces acting along the lateral axis of the airplane.) Under these flight conditions, if the pilot does not compensate for the left yawing moments by holding right rudder pressure, the airplane will tend to make a skidding, wings level turn to the left, causing the ball indicator to be deflected to the right. Most pilots do not, in fact, use enough right rudder to center the ball during takeoff and climb, and may unconsciously hold some right aileron (right wing down slightly) to prevent a left turn, thus climbing in a slight sideslip. A straight climb requires fairly heavy right rudder pressure to keep the ball in center, and this is even more true in a climbing right turn.

Since the left turning tendency requires so much right rudder pressure to maintain coordination in a climb, it can cause a spin to follow from an inadvertent stall, especially on a climbout or go-around. Because he is distracted by the unintentional stall, it is unlikely that the pilot will be applying a proper amount of right rudder pressure to maintain coordinated flight. Thus, the plane is likely to be yawing left as the unintentional stall occurs, and a left spin may follow. This is particularly true of a departure stall in a right turn, since the additional right rudder pressure necessary for coordination in a climbing right turn is apt to be missing. Again, although the stall occurs in a right turn, the uncompensated left turning tendency under such conditions is likely to result in a left spin "over the top." If the stall occurs in a left turn, the ball may not be quite so far to the right when the airplane stalls, but a left spin "out the bottom" will be entered. In fact, some airplanes may be made to enter a left spin when stalled with full power and no use of the rudder controls, simply due to the left yawing moments generated at high angle of attack/high power. Perhaps the best advice to help a pilot avoid a stall under departure conditions is to be particularly aware of aircraft attitude during takeoff and climbout. Do not overload the aircraft because it reduces takeoff and climb performance, particularly on a hot day, and avoid being distracted from the primary task of flying the airplane. If a rudder trim device is installed in the aircraft, it can be used to assist in rudder coordination on takeoff and climb.

IV. FLIGHT AT MINIMUM CONTROLLABLE AIRSPEED (MCA)

This maneuver is used by instructors to familiarize their students with the attitudes, power settings, control feel and principles of flight at high angle of attack. However, some discussion of the aerodynamics of flight at minimum controllable airspeed is helpful in giving pilots a better overall understanding of flight at low airspeeds.

As mentioned earlier in this section, the total drag generated by an aircraft is made up of a parasite drag and an induced drag component. The parasite drag is created because the air resists the forward motion of the aircraft. This type of drag is due partly to pressures on the surface of the aircraft and partly to the friction of air molecules as they flow over the aircraft surfaces. From wind tunnel measurements it has been determined that parasite drag increases as the square of airspeed (V^2). The induced drag is created by the wing as it produces lift. It increases directly with angle of attack, being largest at high angle of attack. Thus, it is largest at low airspeed and smallest at high airspeed.

The individual and total drag curves vary as shown in Figure A-17. Notice that there is an airspeed at which the total drag is a minimum. This airspeed produces maximum range. These drag curves may then be used to compute a power required curve for level flight as shown in Figure A-18. Notice that this curve also shows that there is a certain airspeed at which the power required to sustain level flight is a minimum. This airspeed will produce the maximum flight endurance in hours. The maximum available power produced by the engine as a function of airspeed is also shown. This varies slightly with airspeed due to changes in propeller efficiency over the range of operating airspeeds. Note that the power available and required curves intersect at two airspeeds, a low value and a high value. The low value represents the minimum flight speed at which the engine can produce sufficient power to maintain level flight, and the high value represents the maximum speed attainable in level flight. At speeds between these two, an excess of power is available above that required, so it is possible to climb. The airspeed at which the difference between available and required power is largest, produces the maximum rate of climb (ft/min) and is known as V_y . At speeds less than V_{min} or greater than V_{max} , level flight cannot be maintained. Only a descent is possible because the available power is less than that required for level flight.

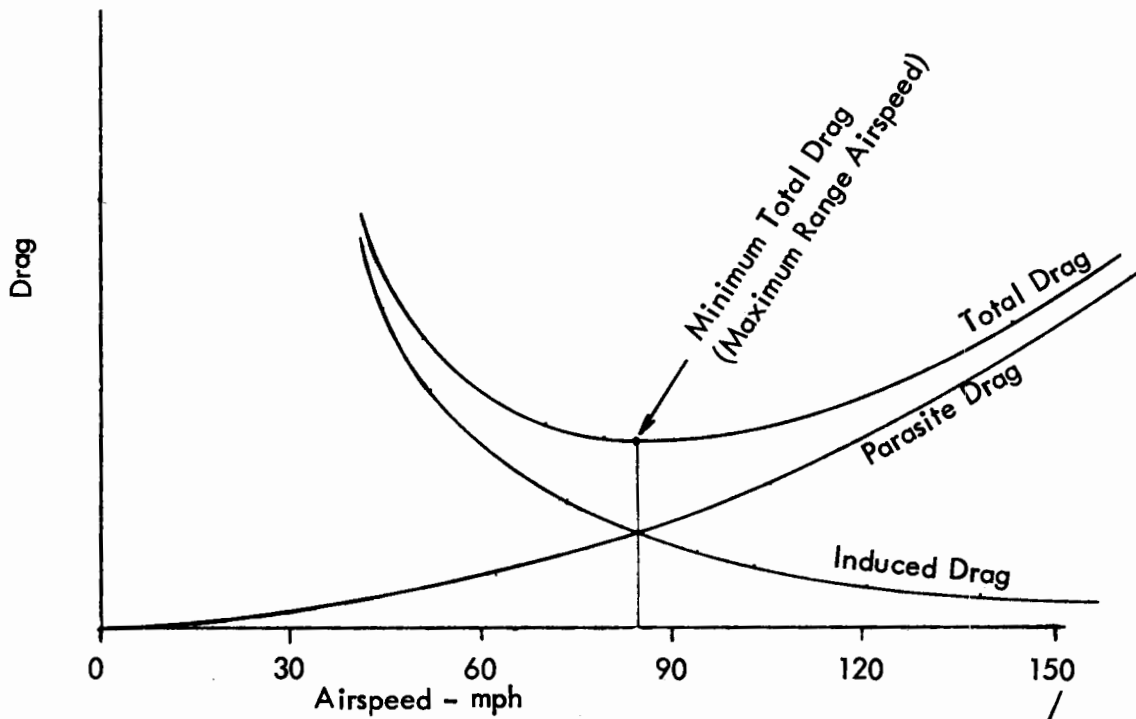

FIGURE A-17. DRAG VS. AIRSPEED.

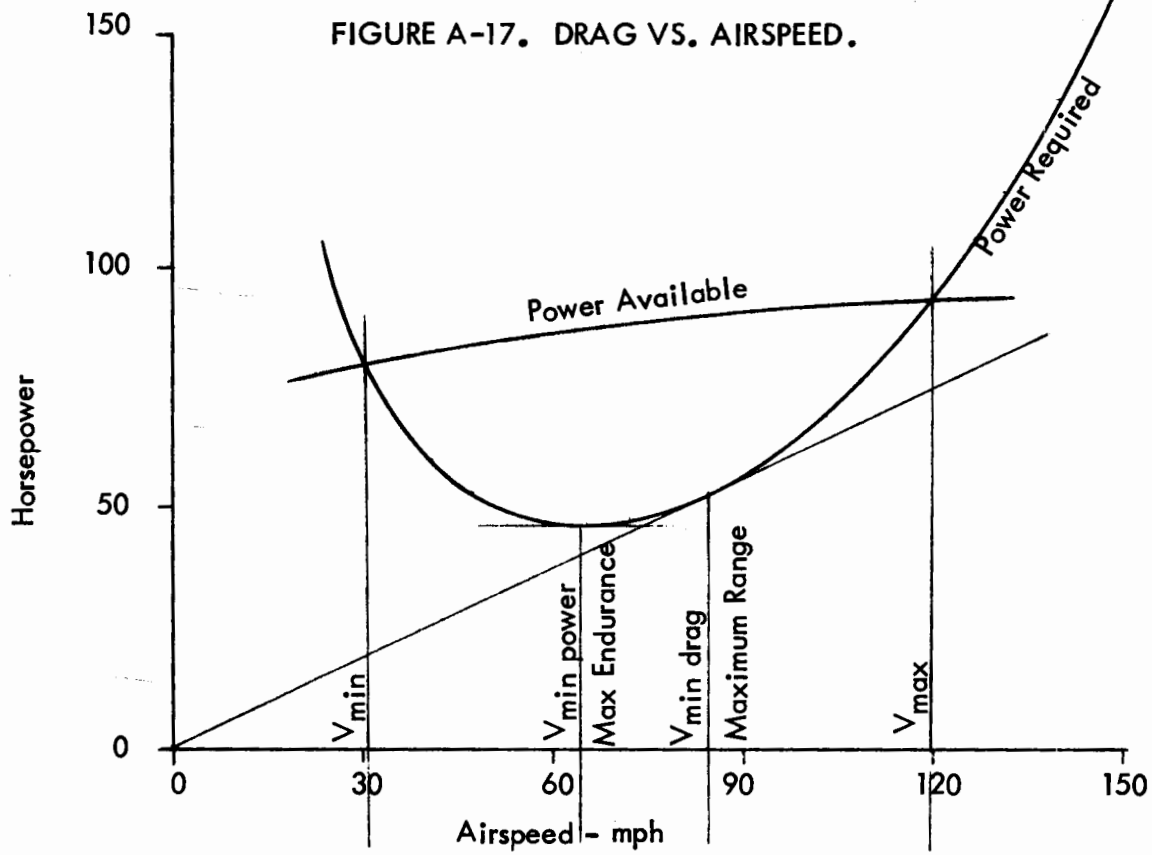

FIGURE A-18. POWER VS. AIRSPEED.

The airspeed $V_{\text{min power}}$ is a very important one, as it represents the dividing line between the "area of normal commands" and the "area of reversed commands." Imagine an airplane flying in unaccelerated level flight at V_{max} , with power available equal to power required. If the pilot raises the nose with back elevator, the plane will slow to some speed below V_{max} . At this new speed, the power available will be greater than required, so the plane will climb, as normally would be the case when the nose is pitched up above level flight attitude. Now consider an airplane at V_{min} , whose pilot applies back elevator to pitch nose up. The airspeed will reduce to below V_{min} , where power available is less than required. Thus the plane will enter a nose high descent, and the effect of elevator on climb performance is just the reverse of what is expected, hence, the name "area of reversed commands." The speed $V_{\text{min power}}$ is approximately the airspeed at which this change from normal to reverse commands occurs. It is close to the best gliding speed. The reason this effect is important to the pilot is as follows. Imagine an airplane on final approach for landing whose correct approach airspeed is 80 mph, which we will assume is the airspeed for minimum power. As the airplane is on short final, the pilot decides he is too low, so he adds nose-up elevator to reduce his rate of descent. What effect will this have? Since the airplane is in the area of reversed commands (or back side of the power curve), raising the nose will only cause an increase in its rate of descent (after it stabilizes at the new, slower airspeed). Thus it will actually only make the airplane even lower on the approach. In this case, the proper response on the part of the pilot would be increased power and cautious nose up pitch, to keep airspeed and rate of descent correct.

V. EFFECT OF FLIGHT CONTROLS AT MINIMUM CONTROLLABLE AIRSPEED

The use of elevator and rudder trim (if available) is proper technique for flight at minimum controllable airspeed. This assists the pilot in maintaining attitude

and airspeed, and also reduces the control forces necessary to maneuver the airplane. If the airplane is trimmed for cruising airspeed, heavy aft control pressure is needed on the elevators and precise control is impossible.

As the airplane is slowed and stabilized near minimum controllable airspeed, elevator effectiveness is reduced due to reduced dynamic pressure on the horizontal tail surfaces. In single engine airplanes, the propeller slipstream may offset this effect somewhat if high power settings are being used. The elevator effectiveness is greater in a power-on stall than in power-off stall, due to the effect of propeller slipstream. Thus, an abrupt, deep stall can occur in a departure configuration due to increased elevator effectiveness.

In modern airplanes, the ailerons are designed to function normally in stalls and at high angle of attack, although their effectiveness is low because of reduced dynamic pressure at low airspeeds. They obviously do not benefit from any slipstream airflow in single engine airplanes. In some older airplanes, ailerons were unreliable at high angle of attack, and could even function in reverse during a stall. To visualize this, imagine an airplane at stalling angle of attack which experiences a roll to the right due to a gust. If the pilot wants to raise the downgoing wing to prevent further rolling, he applies left aileron. This deflects the right aileron trailing edge down, which has the effect of further increasing the angle of attack in the region near the wingtip. This may cause the downgoing tip to stall. The stall causes a further loss of lift on the downgoing tip, reinforcing the original rolling tendency and, in effect, creating a roll response opposite to that desired. Present FARs require that the rolling control show no reversal in a stall. This has been attained on modern airplanes by building "twist" into the wing so that airfoil sections at the tip operate at lower angle of attack than those near the fuselage. Thus, any stall tends to begin

on the inboard sections of the wing, leaving the tips and ailerons unstalled to provide normal roll response. In practice, modern ailerons provide normal but reduced roll response in a stall.

Another undesirable feature, particularly of early aileron designs, is "adverse yaw." This characteristic is most evident at high angle of attack and is present to varying degrees in newer airplanes. Imagine an aircraft in flight at high angle of attack. Assume the pilot begins a turn by entering a bank with the ailerons. The aileron on the upgoing or outside wing is deflected trailing edge down to raise the wing. This has the effect of increasing the drag generated by the upgoing wingtip, since it increases the camber of the airfoil sections near the wingtip. On the contrary, the aileron on the downgoing wingtip is deflected trailing edge up, thus reducing the camber and drag at that wingtip. The effect of these drag changes is to cause the airplane to yaw in the opposite direction to that intended for the turn, hence the name "adverse yaw." This yawing tendency must be opposed by proper use of rudders and is one of the reasons that ailerons are a relatively poor directional control at high angles of attack. In most modern airplane designs, the ailerons are rigged to travel further trailing edge up than trailing edge down. This has somewhat reduced their tendency to cause adverse yaw.

The rudder maintains generally good effectiveness at low airspeeds, especially on single engine airplanes where it is in the propeller slipstream. Also, it usually operates at relatively low angles of attack and therefore does not stall. Consequently, it is effective for lateral/directional control at low airspeeds.

VI. EFFECT OF FLAP EXTENSION AND POWER ON MCA

Flap extension naturally reduces stalling speed, and thus reduces minimum controllable airspeed in level flight. However, due to the effect of slipstream on the

flaps, yawing tendency at MCA or in a stall with flaps extended and high power setting is generally greater than with flaps retracted. The full flap, high power configuration at slow airspeeds is thus worthy of extreme stall awareness, since any inadvertent stalls in this configuration are likely to occur with the aircraft in an uncoordinated flight condition. This situation can occur during a go-around. Full flaps may be set and the pilot is at low airspeed on final approach. When the decision to go-around is made, the pilot adds full power and back elevator pressure to transition to climb attitude, causing a loss of airspeed which may result in a stall. This is particularly true if the flaps are not retracted, are retracted too rapidly, or if too steep a climb is attempted over obstacles, such as might occur if the decision to go around is made too late.

Any airplane operating with flaps down at minimum controllable speed is also subject to a stall if the flaps are retracted too rapidly. In this case, the airplane may be above the flaps-down stalling speed (V_{S_0}) but below the flaps-up stalling speed (V_{S_1}). Sudden retraction of the flaps places the airplane below the flaps up stalling speed in clean configuration and may cause a stall.

VII. WEIGHT AND BALANCE

The subject of weight and balance is frequently not well understood by pilots, yet is of vital importance in the flight characteristics of the airplane.

Weight carried as payload in an airplane has a very great effect on performance. The performance parameters most affected are rate of climb, takeoff ground run, and distance to climb over a 50 foot obstacle, stalling speed, and service ceiling. Overloading an airplane is often the cause of stall/spin accidents during a takeoff/departure. Since ground run and distance to climb over a 50 foot obstacle are increased under these circumstances, an aircraft may be unable to clear obstacles

in its climb path. The pilot may attempt to clear the obstacles by adding nose-up elevator, resulting in a low altitude departure stall. The best prevention for this is to load the airplane only within its certified limits and check the manufacturer's handbook for published takeoff performance figures regarding runway length and obstacle clearance requirements. It is also wise to add some margin to these figures because they are representative of the best performance obtained by an experienced test pilot in a new aircraft with carefully tuned engine. Also remember that published performance figures pertain to operations at sea level and standard temperature (59°F). At higher airport elevations and/or temperatures, takeoff and climb performance are very much reduced because air density is lower than standard. This causes the airplane to perform as it normally would at high altitudes in thinner air (high "density altitude"). In some cases, operations at the maximum certified operating weight may be unsafe, and only operations at reduced weight should be carried out.

In addition to weight, the distribution of the payload in the airplane is important since it determines where the operating center of gravity is located. All airplanes have a range of permissible center of gravity positions at which they may be operated. Stability, stalling characteristics, and spin recovery are all affected by the center of gravity position. As the center of gravity moves aft due to load carried in the rear seats of an airplane, the effective length at which the horizontal tail is located is decreased. This reduces its stabilizing effect. In spins at aft center of gravity locations, the pitch attitude in a stabilized spin is more level. This produces increased angle of attack on the horizontal tail and may make the elevators ineffective in spin recoveries. Some four-place airplanes are certified for spins only with the front seats occupied because recovery from a stabilized spin may be impossible at rear center of gravity locations. Thus, it is vitally important that during daily use of an aircraft, and when intentional spins are conducted, it is operated within approved weight and balance limits for the maneuvers conducted.

APPENDIX B

WRITTEN QUIZZES

This appendix presents the written quizzes that were administered during the Stall Awareness Program ground instruction segment. Quiz No. 1 was given to the subjects prior to any additional ground or flight training. Quiz No. 2 was given to those subjects in the control group, Group 1, immediately after the first quiz. The subjects in Training Groups 2, 3, and 4 were given the second quiz upon completion of the ground training increment.

QUIZ #1

1. Most stall/spin accidents occur
 - a. during practice of intentional spins
 - b. in the traffic pattern (takeoff, approach and landing, go-around)
 - c. when practicing intentional spins in aircraft not certified for them
 - d. when practicing stalls

2. A significant factor which may cause inadvertent stalls is
 - a. distraction
 - b. too lean mixture
 - c. instrument failure
 - d. darkness

3. About what percentage of fatal or serious accidents involve a stall/spin
 - a. 2%
 - b. 5%
 - c. 25%
 - d. 60%

4. An aircraft wing will always stall when
 - a. the indicated airspeed is below the power-off stall speed.
 - b. the angle of attack is greater than the stall angle of attack.
 - c. the calibrated airspeed is below the power-off stall speed.
 - d. the pitch attitude is nose-up.

5. A stall can occur under all conditions except which of the following?
 - a. in a dive
 - b. inverted
 - c. at high airspeed
 - d. at zero angle of attack.

6. An increase in aircraft weight
- a. causes the stall speed to increase
 - b. causes the stall speed to decrease
 - c. will not affect the stall speed unless the center of gravity moves
 - d. will not affect the stall speed except with the flaps down
7. A spin
- a. is a maneuver similar to a spiral in that it occurs at high airspeed in a steep bank and with a high rate of turn.
 - b. never occurs when full power is being used
 - c. requires about the same altitude as a stall for recovery
 - d. is a complex motion in which a stalled airplane is rotating and losing altitude rapidly.
8. Which of the following is true? In a spin,
- a. the airspeed will be near the stall speed
 - b. the turn needle will indicate opposite to the direction of the spin
 - c. the ball indicator will always deflect in the direction of the spin
 - d. the engine will stop
9. Which of the following are necessary to enter a spin?
- a. full rudder and aileron
 - b. full back elevator and full aileron
 - c. a stalled wing and a yawing moment
 - d. a stalled wing and full power
10. Intentional spin entry requires
- a. full nose-up elevator deflection and full rudder in the direction of the spin
 - b. full power
 - c. a steep diving spiral
 - d. rudder and aileron cross controlled

11. Spin recovery is made by
- applying full power and forward wheel
 - reducing power to idle and rudder against the rotation followed by forward wheel
 - applying forward wheel followed by aileron against the spin
 - applying full forward wheel followed by coordinated rollout
12. Accidental stalls are more likely than intentional stalls to be followed by a spin because
- the pilot is not expecting the stall
 - the airplane is likely to be yawing in an unintentional stall
 - both of the above
 - neither of the above
13. An airplane stalled in a left turn tends to spin
- to the left
 - to the right
 - cannot be determined from information given
 - in a direction dependent on rudder position when the airplane stalls.
14. In a skidding turn to the left the ball indicator is deflected
- to the left
 - to the right
 - in the direction of the applied rudder
 - none of the above
15. The most effective control for avoiding a spin and maintaining directional control during a delayed stall recovery is
- rudder
 - aileron
 - throttle
 - rudder trim

16. Aircraft certificated in the normal category
- a. are approved for intentional spins
 - b. have been tested in a six (6) turn spin
 - c. will always recover from a spin
 - d. are not required to be tested in a fully developed spin
17. Adverse yaw is a response produced by which of the following?
- a. rudder
 - b. engine torque
 - c. spoilers
 - d. ailerons

QUIZ #2

1. Stall/spin accidents are most common in all but which of the following situations?
 - a. takeoff and landing
 - b. after engine failure
 - c. during high speed cruise
 - d. during unwarranted flight at low altitude

2. Following engine failure in a climb, the pilot's first action should be to
 - a. hold climb altitude while switching fuel tanks
 - b. check engine instruments
 - c. locate an emergency landing field
 - d. lower the nose to best glide attitude

3. An aircraft wing never stalls when
 - a. the indicated airspeed is above the power-on stall speed
 - b. the angle of attack is less than the stall angle of attack
 - c. the calibrated airspeed is above the power-on stall speed
 - d. the pitch attitude is nose-down

4. A certain type of airplane stalls in level flight at 60 mph at an angle of attack of 18° . Imagine this airplane during a takeoff roll, when it is at an airspeed of 40 mph and 5° angle of attack. At this point in the takeoff roll
 - a. the wing is not stalled
 - b. the wing is stalled
 - c. no lift is being produced
 - d. the wing is stalled but producing some lift

5. The indicated airspeed at which an aircraft will stall
- increases with increased altitude
 - decreases with increased altitude
 - depends on temperature and humidity as well as altitude
 - does not change with altitude
6. Which of the following statements is false?
- An aircraft can stall at airspeeds above the unaccelerated stall speed.
 - An aircraft can stall at any angle of attack
 - An aircraft can be in an unstalled condition at airspeeds below the stall speed.
 - Stall speed increases with increasing load factor
7. Which of the following characteristics of a spin is not characteristic of a steep spiral?
- rapid loss of altitude
 - high rate of rotation
 - stalled wing
 - steep nose-down pitch attitude
8. Intentional spin entry is made with
- full nose-up elevator deflection and full rudder in the direction of the spin
 - a steep diving spiral
 - full power
 - rudder and aileron cross controlled
9. Spin recovery is made by
- applying full power and forward wheel
 - applying full forward wheel followed by coordinated rollout
 - applying forward wheel followed by aileron against the spin
 - reducing power to idle and rudder against the rotation followed by forward wheel

10. A departure stall occurs in a climbing right turn, and the pilot is not applying enough right rudder to center the ball indicator. If the stall is prolonged
- a spin to the left may occur
 - a spin to the right may occur
 - a right yawing tendency will be evident
 - a right rolling tendency will be evident
11. An aft center of gravity location usually
- makes it easier to enter and more difficult to recover from stalls and spins
 - makes it more difficult to enter and easier to recover from stalls and spins
 - can be moved forward during a spin to assure recovery
 - has little effect on stalls and spins
12. An accelerated stall occurs during a steeply banked left turn. Rudder coordination is improper such that the ball indicator is left, indicating a slipping turn. At the stall, the aircraft will
- shudder but continue in the steep turn
 - recover wings level because the rudder counteracts the elevator in a steep turn
 - roll to the left or spin towards the inside of the turn
 - roll to the right or spin towards the outside of the turn
13. An aircraft is in a power-off glide at best gliding speed. If the pilot increases pitch attitude resulting in a nose-up glide at a reduced indicated airspeed, the gliding distance
- increases
 - decreases
 - remains the same
 - may increase or decrease depending on the airplane

14. When operating on the "back side of the power curve" (region of reversed commands)
- a. power to maintain level flight decreases as airspeed decreases
 - b. it is not possible to climb
 - c. increased nose up pitch causes increased rate of descent
 - d. increased nose up pitch does not affect rate of descent
15. Ailerons tend to have reduced effectiveness at high angle of attack and low airspeed
- a. due to high dynamic pressure
 - b. because deflecting an aileron may cause it to stall
 - c. because they are balanced
 - d. because they cause yaw in the direction of a turn
16. The most reliable way to determine the spin characteristics of a new aircraft is
- a. through design specifications
 - b. wind tunnel data
 - c. computer calculation
 - d. flight test
17. Ailerons
- a. are effective for spin recovery
 - b. deflected against a spin may increase or decrease the rotation rate
 - c. Should not be neutralized in a spin
 - d. have an effect which is dependent on aircraft center of gravity position

QUIZ ANSWERS

Quiz No. 1

1. B
2. A
3. C
4. B
5. D
6. A
7. D
8. A
9. C
10. A
11. B
12. C
13. D
14. B
15. A
16. D
17. D

Quiz No. 2

1. C
2. D
3. B
4. A
5. D
6. B
7. C
8. A
9. D
10. A
11. A
12. D
13. B
14. C
15. B
16. D
17. B

APPENDIX C

EXPERIMENTAL RESULTS

This appendix contains all the experimental results obtained for each of the sixty-two subjects participating in the Stall Awareness Program. The data are presented in the format of the computer input data form, which was shown in Figure 5. All subjects' names have been deleted.

*** SUBJECT NO. 1 ***

A. SUBJECT INFORMATION

- 1.
- 2. 21.0
- 3. P
- 4. WH
- 5. P
- 6. 2.0

B. GROUND INSTRUCTION QUIZ GRADES

- 7. 13.0
- 8. 13.0

C. FLIGHT EVALUATION NO. 1

- 9. 12/05
- 10. MG
- 11. 170.0
- 12. 3.0
- 13. 200.0
- 14. 1.0
- 15. 1.0 1.0 1.0 1.0 1.0
- 16. 0. 0. 1. 1. 4.
- 17. 0. 0. 2. 1. 4. 0. 0. 0. 0.
- 18. 25.3
- 19. 0.2
- 20. 1.0
- 21. 2.0 1.5 1.5
- 22. 2.0

D. FLIGHT EVALUATION NO. 2

- 23. 03/12
- 24. MG
- 25. 199.0
- 26. 1.1
- 27. -99.0
- 28. 1.0
- 29. 1.0 1.0 1.0 1.0 1.0
- 30. 3. 0. 1. 2. 2.
- 31. 0. 0. 0. 0. 3. 0. 1. 0. 0.
- 32. 20.0
- 33. 0.0
- 34. 0.0
- 35. 2.0 1.0 1.0
- 36. 2.0
- 37. 0.0

*** SUBJECT NO. 2 ***

A. SUBJECT INFORMATION

1.
2. 18.0
3. N
4. KO
5. P
6. 2.0

B. GROUND INSTRUCTION QUIZ GRADES

7. 10.0
8. 7.0

C. FLIGHT EVALUATION NO. 1

9. 11/18
10. WH
11. 36.7
12. 4.2
13. 25.0
14. 0.0
15. 0.0 -1.0 0.0 -2.0 0.0
16. 2. 0. 3. 1. 0.
0. 0. 1. 0. 2. 1. 0. 0. 0.
17. 0.0
18. 19.3
19. 0.0
20. 0.0
21. -1.0 -2.0 -2.0
22. -1.0

D. FLIGHT EVALUATION NO. 2

23. 02/26
24. MG
25. 60.0
26. 2.2
27. -99.0
28. 0.0
29. 2.0 2.0 2.0 2.0 2.0
30. 2. 0. 0. 3. 2.
0. 0. 0. 2. 3. 0. 0. 0. 0.
31. 0.5
32. 20.5
33. 0.0
34. 0.0
35. 1.0 0.0 0.0
36. 1.5
37. 2.0

*** SUBJECT NO. 3 ***

A. SUBJECT INFORMATION

- 1.
- 2. 18.0
- 3. N
- 4. CN
- 5. C
- 6. 4.0

B. GROUND INSTRUCTION QUIZ GRADES

- 7. 12.0
- 8. 15.0

C. FLIGHT EVALUATION NO. 1

- 9. 12/13
- 10. WH
- 11. 21.0
- 12. 2.0
- 13. 28.0
- 14. 0.0
- 15. 1.0 0.0 -1.0 0.0 2.0
- 16. 1. 1. 1. 0. 1.
0. 0. 1. 0. 1. 2. 0. 0. 0.
- 17. -1.5
- 18. 14.0
- 19. 0.7
- 20. 2.0
- 21. -1.0 -2.0 0.0
- 22. 1.0

D. FLIGHT EVALUATION NO. 2

- 23. /
- 24.
- 25. -99.0
- 26. -99.0
- 27. -99.0
- 28. -99.0
- 29. -99.0 -99.0 -99.0 -99.0 -99.0
- 30. -99. -99. -99. -99. -99.
-99. -99. -99. -99. -99. -99. -99. -99.
- 31. -99.0
- 32. -99.0
- 33. -99.0
- 34. -99.0
- 35. -99.0 -99.0 -99.0
- 36. -99.0
- 37. -99.0

*** SUBJECT NO. 4 ***

A. SUBJECT INFORMATION

1.
2. 22.0
3. N
4. CM
5. F
6. 4.0

B. GROUND INSTRUCTION QUIZ GRADES

7. 6.0
8. 12.0

C. FLIGHT EVALUATION NO. 1

9. 11/06
10. MG
11. 56.0
12. -99.0
13. 22.0
14. -99.0
15. -2.5 -2.0 -2.0 -2.0 -2.0
16. 4. 1. 11. 0. 9.
15. 0. 1. 7. 6. 7. 1. 0. 0.
17. -2.0
18. 21.1
19. 2.6
20. 9.0
21. -2.0 -2.0 -2.0
22. -2.0

D. FLIGHT EVALUATION NO. 2

23. /
24.
25. -99.0
26. -99.0
27. -99.0
28. -99.0
29. -99.0 -99.0 -99.0 -99.0 -99.0
30. -99. -99. -99. -99. -99.
-99. -99. -99. -99. -99. -99. -99. -99. -99.
31. -99.0
32. -99.0
33. -99.0
34. -99.0
35. -99.0 -99.0 -99.0
36. -99.0
37. -99.0

*** SUBJECT NO. 5 ***

A. SUBJECT INFORMATION

1.
2. 18.0
3. N
4. BC
5. F
6. 1.0

B. GROUND INSTRUCTION QUIZ GRADES

7. 7.0
8. 9.0

C. FLIGHT EVALUATION NO. 1

9. 11/18
10. MG
11. 11.0
12. 1.4
13. 25.0
14. 0.0
15. -1.0 0.0 0.0 0.0 -2.0
16. 7. 3. 9. 0. 13. 9. 7. 0. 0.
17. 5. 2. 6. 5. 9.
17. -2.0
18. 21.5
19. 1.3
20. 3.0
21. 1.0 -1.0 1.0
22. -2.0

D. FLIGHT EVALUATION NO. 2

23. 02/26
24. MG
25. 24.0
26. 0.6
27. -99.0
28. 0.0
29. 1.0 -1.0 -0.5 -1.0 -2.0
30. 3. 0. 3. 1. 1. 0. 0. 0. 0.
31. 0. 0. 2. 0. 4.
32. 19.6
33. 0.6
34. 2.0
35. 0.0 0.0 -1.0
36. 0.0
37. 1.0

*** SUBJECT NO. 6 ***

A. SUBJECT INFORMATION

1.
2. 18.0
3. N
4. CN
5. C
6. 3.0

B. GROUND INSTRUCTION QUIZ GRADES

7. 9.0
8. 12.0

C. FLIGHT EVALUATION NO. 1

9. 01/30
10. MG
11. 10.9
12. 0.2
13. 10.0
14. 0.0
15. 0.0 -1.0 -1.0 -1.0 -1.0
16. 0. 0. 1. 0. 0.
1. 1. 1. 0. 0. 1. 0. 1. 1.
17. 0.5
18. 17.4
19. 1.2
20. 4.0
21. -1.0 -1.0 -1.0
22. 0.5

D. FLIGHT EVALUATION NO. 2

23. /
24.
25. -99.0
26. -99.0
27. -99.0
28. -99.0
29. -99.0 -99.0 -99.0 -99.0 -99.0
30. -99. -99. -99. -99. -99.
-99. -99. -99. -99. -99. -99. -99. -99.
31. -99.0
32. -99.0
33. -99.0
34. -99.0
35. -99.0 -99.0 -99.0
36. -99.0
37. -99.0

*** SUBJECT NO. 7 ***

A. SUBJECT INFORMATION

- 1.
- 2. -99.0
- 3. N
- 4. TM
- 5. C
- 6. 3.0

B. GROUND INSTRUCTION QUIZ GRADES

- 7. 11.0
- 8. 14.0

C. FLIGHT EVALUATION NO. 1

- 9. 02/03
- 10. MG
- 11. 17.0
- 12. 0.6
- 13. 25.0
- 14. 0.0
- 15. 0.0 0.0 -1.0 0.0 -1.0
- 16. 1. 0. 0. 1. 1. 0. 0. 0. 0.
- 17. 0.0
- 18. 20.0
- 19. -99.0
- 20. -99.0
- 21. -99.0 -99.0 -99.0
- 22. 0.0

D. FLIGHT EVALUATION NO. 2

- 23. 04/14
- 24. KG
- 25. 34.0
- 26. 1.2
- 27. 35.0
- 28. 0.0
- 29. 1.0 1.0 -2.0 1.0 -2.0
- 30. 0. 0. 0. 0. 1. 0. 0. 0. 0.
- 31. 1.5
- 32. 14.0
- 33. 0.3
- 34. 1.0
- 35. 1.0 1.0 0.0
- 36. 1.0
- 37. 1.0

*** SUBJECT NO. 8 ***

A. SUBJECT INFORMATION

1.
2. 17.0
3. N
4. CN
5. C
6. 3.0

B. GROUND INSTRUCTION QUIZ GRADES

7. 14.0
8. 17.0

C. FLIGHT EVALUATION NO. 1

9. 10/04
10. WH
11. 13.0
12. 1.9
13. 22.0
14. 0.0
15. 1.0 -1.0 -2.0 -1.0 -2.0
16. 1. 0. 4. 3. 2.
0. 2. 4. 0. 2. 7. 0. 2. 0.
17. 1.0
18. 11.0
19. 0.7
20. 3.0
21. -2.0 -2.0 -2.0
22. -2.0

D. FLIGHT EVALUATION NO. 2

23. 04/14
24. KG
25. 25.0
26. 1.4
27. 34.0
28. 0.0
29. 0.0 0.0 -2.0 -1.0 -1.0
30. 3. 0. 0. 0. 5.
0. 0. 4. 0. 4. 5. 1. 0. 0.
31. 1.5
32. 12.0
33. 0.0
34. 0.0
35. -1.0 0.0 0.0
36. -1.0
37. 1.0

*** SUBJECT NO. 9 ***

A. SUBJECT INFORMATION

- 1.
- 2. 19.0
- 3. N
- 4. RP
- 5. C
- 6. 4.0

B. GROUND INSTRUCTION QUIZ GRADES

- 7. 12.0
- 8. 12.0

C. FLIGHT EVALUATION NO. 1

- 9. 02/12
- 10. MG
- 11. 27.0
- 12. 0.5
- 13. 50.0
- 14. 0.0
- 15. -1.0 0.0 0.0 0.0 0.0
- 16. 0. 0. 0. 0. 0.
- 17. 0.0 0. 0. 0. 0. 0. 0. 0.
- 18. 22.0
- 19. -99.0
- 20. -99.0
- 21. 0.0 -1.0 0.0
- 22. 0.5

D. FLIGHT EVALUATION NO. 2

- 23. 05/05
- 24. KG
- 25. 39.0
- 26. 0.5
- 27. 55.0
- 28. 4.0
- 29. 2.0 3.0 3.0 1.0 3.0
- 30. 0. 0. 0. 0. 0.
- 31. 0.7 0. 0. 0. 0. 0. 0. 0.
- 32. 8.0
- 33. 0.0
- 34. 0.0
- 35. 1.0 1.0 1.0
- 36. 1.0
- 37. 1.0

*** SUBJECT NO. 10 ***

A. SUBJECT INFORMATION

- 1.
- 2. 20.0
- 3. N
- 4. JG
- 5. C
- 6. 3.0

B. GROUND INSTRUCTION QUIZ GRADES

- 7. 10.0
- 8. 17.0

C. FLIGHT EVALUATION NO. 1

- 9. 11/06
- 10. WH
- 11. 13.9
- 12. 1.8
- 13. 28.0
- 14. 0.0
- 15. 0.0 1.0 0.0 0.0 1.0
- 16. 1. 0. 0. 1. 2.
- 17. 0. 0. 0. 1. 1. 1. 0. 0. 0.
- 18. 0.3
- 19. 17.0
- 20. 0.4
- 21. 2.0
- 22. 0.0 -1.0 -1.0
- 23. 1.0

D. FLIGHT EVALUATION NO. 2

- 23. /
- 24.
- 25. -99.0
- 26. -99.0
- 27. -99.0
- 28. -99.0
- 29. -99.0 -99.0 -99.0 -99.0 -99.0
- 30. -99. -99. -99. -99. -99.
- 31. -99. -99. -99. -99. -99. -99. -99. -99. -99.
- 32. -99.0
- 33. -99.0
- 34. -99.0
- 35. -99.0 -99.0 -99.0
- 36. -99.0
- 37. -99.0

*** SUBJECT NO. 11 ***

A. SUBJECT INFORMATION

- 1.
- 2. 28.0
- 3. N
- 4. CM
- 5. F
- 6. 1.0

B. GROUND INSTRUCTION QUIZ GRADES

- 7. 10.0
- 8. 8.0

C. FLIGHT EVALUATION NO. 1

- 9. 11/07
- 10. MG
- 11. 9.0
- 12. 1.2
- 13. 5.0
- 14. 0.0
- 15. -1.0 -1.0 -1.0 -2.0 -1.0
- 16. 1. 0. 2. 0. 4.
- 17. 2. 2. 0. 1. 3. 2. 3. 0. 0.
- 18. -99.0
- 19. 17.0
- 20. 1.8
- 21. 7.0
- 22. -2.0 -1.0 -1.0
- 23. -1.0

D. FLIGHT EVALUATION NO. 2

- 23. 02/25
- 24. MG
- 25. 45.0
- 26. 2.6
- 27. -99.0
- 28. 0.0
- 29. 1.0 0.0 1.0 0.0 0.0
- 30. 5. 0. 2. 0. 3.
- 31. 3. 0. 0. 1. 5. 0. 1. 0. 0.
- 32. 0.0
- 33. 18.5
- 34. 1.5
- 35. 4.0
- 36. 1.0 0.0 0.0
- 37. 0.0
- 38. 1.0

*** SUBJECT NO. 12 ***

A. SUBJECT INFORMATION

- 1.
- 2. 27.0
- 3. N
- 4. JG
- 5. C
- 6. 4.0

B. GROUND INSTRUCTION QUIZ GRADES

- 7. 14.0
- 8. 11.0

C. FLIGHT EVALUATION NO. 1

- 9. 02/12
- 10. MG
- 11. 20.0
- 12. 2.6
- 13. 36.0
- 14. 0.0
- 15. 1.0 0.0 0.0 0.0 1.0
- 16. 0. 0. 0. 0. 0.
- 17. 0. 0. 0. 0. 0. 0. 0. 0. 0.
- 18. 1.0
- 19. 20.1
- 20. 1.3
- 21. 3.0
- 22. -1.0 0.0 -2.0
- 23. 1.5

D. FLIGHT EVALUATION NO. 2

- 23. 04/14
- 24. KG
- 25. 40.0
- 26. 2.3
- 27. 45.0
- 28. 4.0
- 29. 1.0 1.0 -1.0 0.0 -1.0
- 30. 0. 0. 0. 0. 0.
- 31. 0. 0. 0. 0. 0. 0. 0. 0. 0.
- 32. 3.0
- 33. 19.0
- 34. 0.0
- 35. 0.0
- 36. -1.0 2.0 1.0
- 37. 2.0
- 38. 1.0

*** SUBJECT NO. 13 ***

A. SUBJECT INFORMATION

- 1.
- 2. -99.0
- 3. N
- 4. BM
- 5. C
- 6. 2.0

B. GROUND INSTRUCTION QUIZ GRADES

- 7. 16.0
- 8. 13.0

C. FLIGHT EVALUATION NO. 1

- 9. 12/11
- 10. WN
- 11. 85.0
- 12. 1.4
- 13. 20.0
- 14. 0.0
- 15. 0.0 1.0 0.0 0.0 0.0
- 16. 0. 0. 0. 0. 0.
- 17. 0. 0. 0. 0. 0. 0. 0. 0. 0.
- 18. 20.5
- 19. 0.6
- 20. 2.0
- 21. 0.5 1.0 0.0
- 22. 1.0

D. FLIGHT EVALUATION NO. 2

- 23. /
- 24.
- 25. -99.0
- 26. -99.0
- 27. -99.0
- 28. -99.0
- 29. -99.0 -99.0 -99.0 -99.0 -99.0
- 30. -99. -99. -99. -99. -99.
- 31. -99. -99. -99. -99. -99. -99. -99. -99.
- 32. -99.0
- 33. -99.0
- 34. -99.0
- 35. -99.0 -99.0 -99.0
- 36. -99.0
- 37. -99.0

*** SUBJECT NO. 14 ***

A. SUBJECT INFORMATION

1.
2. 20.0
3. N
4. CM
5. P
6. 1.0

B. GROUND INSTRUCTION QUIZ GRADES

7. 8.0
8. 12.0

C. FLIGHT EVALUATION NO. 1

9. 11/19
10. MG
11. 5.0
12. 0.6
13. 10.0
14. 0.0
15. -1.0 -1.0 -1.0 -1.0 -1.0
16. 2. 3. 5. 0. 1.
0. 0. 0. 0. 0. 0. 2. 0. 0.
17. -1.0
18. 15.5
19. 0.1
20. 1.0
21. -1.0 -1.0 -1.0
22. 0.0

D. FLIGHT EVALUATION NO. 2

23. 03/06
24. WH
25. 14.0
26. 0.3
27. -99.0
28. 0.0
29. -1.0 -1.0 0.0 -1.0 0.0
30. 3. 0. 5. 0. 5.
0. 1. 1. 0. 8. 0. 1. 0. 0.
31. 0.0
32. 24.3
33. 0.0
34. 0.0
35. -1.0 -2.0 -2.0
36. 0.0
37. 0.0

*** SUBJECT NO. 15 ***

A. SUBJECT INFORMATION

1.
2. 19.0
3. N
4. CM
5. F
6. 3.0

B. GROUND INSTRUCTION QUIZ GRADES

7. 8.0
8. 11.0

C. FLIGHT EVALUATION NO. 1

9. 11/19
10. MG
11. 5.8
12. 0.8
13. 10.0
14. 0.0
15. 0.0 -1.0 -1.0 -1.0 -2.0
16. 4. 0. 10. 2. 6.
0. 0. 1. 0. 5. 3. 3. 0. 0.
17. 0.0
18. 16.4
19. 1.3
20. 4.0
21. -2.0 -2.0 -2.0
22. -2.0

D. FLIGHT EVALUATION NO. 2

23. 04/08
24. WH
25. 37.0
26. 2.3
27. 20.0
28. 0.0
29. -1.0 -1.0 0.0 -1.0 -1.0
30. 4. 0. 10. 0. 2.
2. 0. 1. 2. 0. 0. 5. 0. 0.
31. 0.0
32. 20.0
33. 2.5
34. 6.0
35. 1.0 -1.0 -1.0
36. -2.0
37. 0.5

*** SUBJECT NO. 16 ***

A. SUBJECT INFORMATION

1.
2. 20.0
3. N
4. KK
5. F
6. 1.0

B. GROUND INSTRUCTION QUIZ GRADES

7. 7.0
8. 9.0

C. FLIGHT EVALUATION NO. 1

9. 12/01
10. MG
11. 17.3
12. 0.0
13. 75.0
14. 0.0
15. -1.0 -1.0 -1.0 -1.0 -1.0
16. 6. 2. 16. 1. 3.
0. 2. 5. 0. 8. 11. 5. 0. 0.
17. -2.0
18. 12.5
19. 0.6
20. 3.0
21. -1.0 -2.0 -2.0
22. -1.0

D. FLIGHT EVALUATION NO. 2

23. 03/08
24. MG
25. 25.6
26. 0.6
27. -99.0
28. 0.0
29. -1.0 -1.0 -1.0 -1.0 -1.0
30. 1. 0. 3. 0. 0.
0. 0. 1. 1. 2. 0. 1. 0. 0.
31. -99.0
32. 5.0
33. 3.4
34. 10.0
35. -1.0 -2.0 -2.0
36. -1.0
37. 0.0

*** SUBJECT NO. 17 ***

A. SUBJECT INFORMATION

- 1.
- 2. -99.0
- 3. N
- 4. RF
- 5. C
- 6. 2.0

B. GROUND INSTRUCTION QUIZ GRADES

- 7. -99.0
- 8. -99.0

C. FLIGHT EVALUATION NO. 1

- 9. 01/30
 - 10. MG
 - 11. 30.9
 - 12. 0.3
 - 13. 20.0
 - 14. 0.0
 - 15. -1.0 -2.0 -2.0 -2.0 -99.0
 - 16. 0. 0. 3. 0. 0.
 - 17. 0.0
 - 18. 12.0
 - 19. 3.6
 - 20. -99.0
 - 21. -2.0 -1.0 -1.0
 - 22. -1.0
0. 3. 3. 0. 0.

D. FLIGHT EVALUATION NO. 2

- 23. /
 - 24.
 - 25. -99.0
 - 26. -99.0
 - 27. -99.0
 - 28. -99.0
 - 29. -99.0 -99.0 -99.0 -99.0 -99.0
 - 30. -99. -99. -99. -99. -99.
 - 31. -99.0
 - 32. -99.0
 - 33. -99.0
 - 34. -99.0
 - 35. -99.0 -99.0 -99.0
 - 36. -99.0
 - 37. -99.0
- 99. -99. -99. -99.

*** SUBJECT NO. 18 ***

A. SUBJECT INFORMATION

- 1.
- 2. 27.0
- 3. N
- 4. BM
- 5. C
- 6. 3.0

B. GROUND INSTRUCTION QUIZ GRADES

- 7. 13.0
- 8. -99.0

C. FLIGHT EVALUATION NO. 1

- 9. 12/17
- 10. MG
- 11. 59.0
- 12. 1.1
- 13. 40.0
- 14. 0.0
- 15. 1.0 0.0 1.0 0.0 1.0
- 16. 0. 0. 0. 0. 0.
- 17. 0. 0. 0. 0. 0. 0. 0. 0. 0.
- 18. 1.5
- 19. 25.3
- 20. 0.1
- 21. 1.0
- 22. 2.0 1.0 1.0
- 23. 2.5

D. FLIGHT EVALUATION NO. 2

- 23. /
- 24.
- 25. -99.0
- 26. -99.0
- 27. -99.0
- 28. -99.0
- 29. -99.0 -99.0 -99.0 -99.0 -99.0
- 30. -99. -99. -99. -99. -99.
- 31. -99. -99. -99. -99. -99. -99. -99. -99.
- 32. -99.0
- 33. -99.0
- 34. -99.0
- 35. -99.0 -99.0 -99.0
- 36. -99.0
- 37. -99.0

*** SUBJECT NO. 19 ***

A. SUBJECT INFORMATION

- 1.
- 2. 21.0
- 3. F
- 4. KO
- 5. F
- 6. 3.0

B. GROUND INSTRUCTION QUIZ GRADES

- 7. 10.0
- 8. 10.0

C. FLIGHT EVALUATION NO. 1

- 9. 12/15
- 10. MG
- 11. 77.0
- 12. 2.0
- 13. -99.0
- 14. 5.0
- 15. 1.0 1.0 1.0 1.0 0.0
- 16. 3. 0. 4. 0. 3. 2. 0. 0. 0.
- 17. 0.5
- 18. 19.0
- 19. 1.4
- 20. 6.0
- 21. 0.0 0.0 0.0
- 22. 0.0

D. FLIGHT EVALUATION NO. 2

- 23. 04/03
- 24. MG
- 25. 87.0
- 26. 1.6
- 27. -99.0
- 28. 5.0
- 29. -1.0 -1.0 1.0 -2.0 1.0
- 30. 1. 0. 5. 0. 0. 0. 0. 0. 0.
- 31. 0.0
- 32. 14.3
- 33. 2.3
- 34. 6.0
- 35. 0.0 -1.0 0.0
- 36. 0.0
- 37. 0.0

*** SUBJECT NO. 20 ***

A. SUBJECT INFORMATION

- 1.
- 2. 16.0
- 3. N
- 4. JG
- 5. C
- 6. 4.0

B. GROUND INSTRUCTION QUIZ GRADES

- 7. 10.0
- 8. 10.0

C. FLIGHT EVALUATION NO. 1

- 9. 10/31
- 10. MG
- 11. 20.0
- 12. 1.8
- 13. 3.0
- 14. 0.0
- 15. 2.0 2.0 1.0 0.0 1.0
- 16. 0. 0. 1. 0. 0.
- 17. 0. 0. 0. 0. 1. 1. 0. 0. 0.
- 18. 1.0
- 19. 20.0
- 20. 0.0
- 21. 0.0
- 22. 1.0 1.0 1.0
- 23. 2.0

D. FLIGHT EVALUATION NO. 2

- 23. /
- 24.
- 25. -99.0
- 26. -99.0
- 27. -99.0
- 28. -99.0
- 29. -99.0 -99.0 -99.0 -99.0 -99.0
- 30. -99. -99. -99. -99. -99.
- 31. -99. -99. -99. -99. -99. -99. -99. -99.
- 32. -99.0
- 33. -99.0
- 34. -99.0
- 35. -99.0 -99.0 -99.0
- 36. -99.0
- 37. -99.0

*** SUBJECT NO. 21 ***

A. SUBJECT INFORMATION

- 1.
- 2. 25.0
- 3. P
- 4. WH
- 5. P
- 6. 4.0

B. GROUND INSTRUCTION QUIZ GRADES

- 7. 14.0
- 8. 16.0

C. FLIGHT EVALUATION NO. 1

- 9. 11/06
- 10. MG
- 11. 120.0
- 12. 0.3
- 13. 50.0
- 14. 5.0
- 15. 2.5 2.5 2.5 2.5 2.5
- 16. 1. 0. 0. 0. 1.
- 0. 0. 0. 0. 0. 0. 0. 0.
- 17. -99.0
- 18. 15.0
- 19. 0.0
- 20. 0.0
- 21. 2.5 2.5 2.5
- 22. 2.5

D. FLIGHT EVALUATION NO. 2

- 23. 04/17
- 24. MG
- 25. 145.0
- 26. 0.6
- 27. -99.0
- 28. 15.0
- 29. 2.5 2.5 2.5 2.5 0.0
- 30. 0. 0. 0. 0. 0.
- 0. 0. 0. 0. 0. 0. 0. 0.
- 31. -99.0
- 32. 18.5
- 33. 0.2
- 34. 1.0
- 35. 2.0 1.0 2.0
- 36. 2.5
- 37. 0.0

*** SUBJECT NO. 22 ***

A. SUBJECT INFORMATION

- 1.
- 2. 21.0
- 3. N
- 4. BC
- 5. F
- 6. 1.0

B. GROUND INSTRUCTION QUIZ GRADES

- 7. 12.0
- 8. 6.0

C. FLIGHT EVALUATION NO. 1

- 9. 11/06
- 10. MG
- 11. 7.0
- 12. 1.1
- 13. 12.0
- 14. 0.0
- 15. 0.0 0.0 0.0 0.0 -1.0
- 16. 4. 0. 8. 3. 3. 2. 3. 0. 0.
- 17. 0. 0. 1. 3. 6.
- 17. -99.0
- 18. 17.0
- 19. 0.5
- 20. 1.0
- 21. 0.0 0.0 0.0
- 22. -1.0

D. FLIGHT EVALUATION NO. 2

- 23. 03/08
- 24. MG
- 25. 33.0
- 26. 1.2
- 27. -99.0
- 28. 0.0
- 29. 1.0 1.5 1.5 1.5 2.0
- 30. 0. 0. 3. 0. 4. 0. 2. 0. 0.
- 31. 0. 0. 1. 1. 3.
- 31. -99.0
- 32. 17.0
- 33. 1.0
- 34. 4.0
- 35. 2.0 -1.0 -1.0
- 36. 0.0
- 37. 1.0

*** SUBJECT NO. 23 ***

A. SUBJECT INFORMATION

- 1.
- 2. 19.0
- 3. N
- 4. CM
- 5. F
- 6. 3.0

B. GROUND INSTRUCTION QUIZ GRADES

- 7. -99.0
- 8. 14.0

C. FLIGHT EVALUATION NO. 1

- 9. 11/04
- 10. MG
- 11. 81.0
- 12. 1.9
- 13. 50.0
- 14. 0.0
- 15. 0.0 0.0 -1.0 0.0 1.0
- 16. 1. 0. 5. 1. 4.
- 17. 1. 0. 2. 0. 7. 4. 0. 0. 0.
- 18. 0.0
- 19. 19.0
- 20. 6.0
- 21. 8.0
- 22. -1.0 -1.0 -1.0
- 23. -2.0

D. FLIGHT EVALUATION NO. 2

- 23. 03/11
- 24. MG
- 25. 99.0
- 26. 1.4
- 27. -99.0
- 28. 0.0
- 29. 1.5 1.5 1.0 1.5 1.0
- 30. 5. 0. 6. 0. 1.
- 31. 0. 0. 0. 0. 4. 1. 2. 0. 0.
- 32. 1.0
- 33. 20.0
- 34. 0.3
- 35. 1.0
- 36. -1.0 -1.0 -1.0
- 37. 0.0
- 38. 2.0

*** SUBJECT NO. 24 ***

A. SUBJECT INFORMATION

- 1.
- 2. 45.0
- 3. N
- 4. RP
- 5. C
- 6. 4.0

B. GROUND INSTRUCTION QUIZ GRADES

- 7. 9.0
- 8. 13.0

C. FLIGHT EVALUATION NO. 1

- 9. 10/31
- 10. MG
- 11. 16.0
- 12. 1.3
- 13. 10.0
- 14. 0.0
- 15. 1.0 -1.0 -1.0 -1.0 -1.0
- 16. 1. 0. 2. 1. 1.
- 17. 3. 0. 0. 0. 0. 3. 0. 1. 1.
- 18. -99.0
- 19. 21.0
- 20. 1.5
- 21. 2.0
- 22. 0.0 -1.0 1.0
- 23. 1.0

D. FLIGHT EVALUATION NO. 2

- 23. 04/19
- 24. KG
- 25. 24.0
- 26. 0.7
- 27. 20.0
- 28. 4.0
- 29. 3.0 1.0 2.0 1.0 3.0
- 30. 0. 0. 0. 0. 0.
- 31. 0. 0. 0. 0. 0. 0. 0. 0. 0.
- 32. 1.5
- 33. 12.0
- 34. 1.5
- 35. 2.0
- 36. 0.0 1.0 2.0
- 37. 2.0
- 38. 2.0

*** SUBJECT NO. 25 ***

A. SUBJECT INFORMATION

- 1.
- 2. 19.0
- 3. N
- 4. KD
- 5. F
- 6. 1.0

B. GROUND INSTRUCTION QUIZ GRADES

- 7. 8.0
- 8. 7.0

C. FLIGHT EVALUATION NO. 1

- 9. 11/26
- 10. MG
- 11. 8.0
- 12. 0.8
- 13. 20.0
- 14. 0.0
- 15. -1.0 0.0 -1.0 0.0 -1.0
- 16. 2. 2. 3. 3. 2.
- 17. 0. 1. 0. 0. 2. 5. 2. 0. 0.
- 18. -0.5
- 19. 19.2
- 20. 0.1
- 21. 2.0
- 22. 0.0 1.0 1.0
- 23. 1.0

D. FLIGHT EVALUATION NO. 2

- 23. 02/27
- 24. MG
- 25. 19.0
- 26. 0.8
- 27. -99.0
- 28. 0.0
- 29. -1.0 -1.0 0.0 0.0 -1.0
- 30. 0. 0. 2. 2. 4.
- 31. 4. 0. 0. 2. 2. 1. 0. 0. 0.
- 32. -99.0
- 33. 17.3
- 34. 0.9
- 35. 4.0
- 36. 0.0 0.0 0.0
- 37. 1.0
- 38. 0.0

*** SUBJECT NO. 26 ***

A. SUBJECT INFORMATION

1.
2. 19.0
3. N
4. CM
5. P
6. 3.0

B. GROUND INSTRUCTION QUIZ GRADES

7. 7.0
8. 11.0

C. FLIGHT EVALUATION NO. 1

9. 11/20
10. MG
11. 34.0
12. 1.0
13. 25.0
14. 0.0
15. -2.0 -1.0 -1.0 -1.0 -1.0
16. 8. 0. 8. 3. 10.
17. 18. 1. 1. 2. 9. 9. 2. 0. 0.
18. 0.0
19. 12.5
20. 5.5
21. 20.0
22. -2.0 -2.0 -2.0
23. -2.0

D. FLIGHT EVALUATION NO. 2

23. 03/11
24. MG
25. 47.0
26. 0.6
27. -99.0
28. 0.0
29. -2.0 -1.0 -1.0 -1.0 -1.0
30. 6. 0. 3. 0. 6.
31. 0. 1. 1. 1. 4. 0. 1. 0. 0.
32. -99.0
33. -99.0
34. 0.7
35. 3.0
36. -1.0 -2.0 -1.0
37. -1.0
38. 2.0

*** SUBJECT NO. 27 ***

A. SUBJECT INFORMATION

- 1.
- 2. 23.0
- 3. N
- 4. BM
- 5. C
- 6. 1.0

B. GROUND INSTRUCTION QUIZ GRADES

- 7. -99.0
- 8. -99.0

C. FLIGHT EVALUATION NO. 1

- 9. 12/11
- 10. WN
- 11. 47.0
- 12. 2.4
- 13. 70.0
- 14. 0.0
- 15. 1.0 1.0 1.0 1.0 1.0
- 16. 0. 0. 1. 0. 0.
- 17. 0. 0. 0. 0. 1. 0. 0. 0. 0.
- 18. 0.0
- 19. 23.0
- 20. 0.3
- 21. 3.0
- 22. 1.0 0.0 0.0
- 23. 0.5

D. FLIGHT EVALUATION NO. 2

- 23. /
- 24.
- 25. -99.0
- 26. -99.0
- 27. -99.0
- 28. -99.0
- 29. -99.0 -99.0 -99.0 -99.0 -99.0
- 30. -99. -99. -99. -99. -99.
- 31. -99. -99. -99. -99. -99. -99. -99. -99.
- 32. -99.0
- 33. -99.0
- 34. -99.0
- 35. -99.0 -99.0 -99.0
- 36. -99.0
- 37. -99.0

*** SUBJECT NO. 28 ***

A. SUBJECT INFORMATION

- 1.
- 2. 20.0
- 3. N
- 4. RP
- 5. C
- 6. 1.0

B. GROUND INSTRUCTION QUIZ GRADES

- 7. 3.0
- 8. 4.0

C. FLIGHT EVALUATION NO. 1

- 9. 02/12
- 10. MG
- 11. 9.0
- 12. 0.1
- 13. 20.0
- 14. 0.0
- 15. 1.0 -1.0 1.0 -1.0 0.0
- 16. 3. 0. 3. 0. 0. 3. 0. 1. 1.
- 17. 0.0
- 18. 18.0
- 19. 1.2
- 20. 2.0
- 21. -1.0 -1.0 0.0
- 22. -0.5

D. FLIGHT EVALUATION NO. 2

- 23. 05/21
- 24. KG
- 25. 22.0
- 26. 0.9
- 27. 35.0
- 28. 0.0
- 29. -99.0 -99.0 -99.0 -99.0 -99.0
- 30. 0. 0. 0. 0. 1. 1. 0. 1. 1.
- 31. 0.5
- 32. 11.6
- 33. 0.5
- 34. 2.0
- 35. -1.0 0.0 -1.0
- 36. -0.5
- 37. 0.0

*** SUBJECT NO. 29 ***

A. SUBJECT INFORMATION

- 1.
- 2. 20.0
- 3. F
- 4. KK
- 5. P
- 6. 3.0

B. GROUND INSTRUCTION QUIZ GRADES

- 7. 9.0
- 8. 12.0

C. FLIGHT EVALUATION NO. 1

- 9. 11/26
- 10. MG
- 11. 144.0
- 12. 0.4
- 13. 45.0
- 14. 0.0
- 15. 0.0 1.0 0.0 -0.5 1.0
- 16. 3. 0. 4. 1. 2.
0. 0. 2. 2. 3. 1. 0. 0. 0.
- 17. 0.7
- 18. 20.0
- 19. 0.7
- 20. 5.0
- 21. 2.0 2.0 2.0
- 22. 1.0

D. FLIGHT EVALUATION NO. 2

- 23. /
- 24.
- 25. -99.0
- 26. -99.0
- 27. -99.0
- 28. -99.0
- 29. -99.0 -99.0 -99.0 -99.0 -99.0
- 30. -99. -99. -99. -99. -99.
-99. -99. -99. -99. -99. -99. -99. -99. -99.
- 31. -99.0
- 32. -99.0
- 33. -99.0
- 34. -99.0
- 35. -99.0 -99.0 -99.0
- 36. -99.0
- 37. -99.0

*** SUBJECT NO. 30 ***

A. SUBJECT INFORMATION

- 1.
- 2. 34.0
- 3. N
- 4. BF
- 5. F
- 6. 2.0

B. GROUND INSTRUCTION QUIZ GRADES

- 7. 6.0
- 8. 9.0

C. FLIGHT EVALUATION NO. 1

- 9. 12/02
- 10. MG
- 11. 18.0
- 12. 0.6
- 13. 0.0
- 14. 0.0
- 15. -2.0 -1.0 -2.0 -3.0 -2.0
- 16. 4. 0. 15. 2. 4.
2. 3. 5. 0. 4. 4. 3. 0. 0.
- 17. 0.0
- 18. 18.3
- 19. 1.2
- 20. 5.0
- 21. -2.0 -3.0 -3.0
- 22. -2.5

D. FLIGHT EVALUATION NO. 2

- 23. 02/26
- 24. MG
- 25. 25.0
- 26. 0.5
- 27. 21.0
- 28. 0.0
- 29. 0.0 0.0 -1.0 -1.0 -1.0
- 30. 2. 0. 2. 3. 4.
0. 0. 1. 0. 2. 2. 0. 0. 0.
- 31. -1.0
- 32. 19.4
- 33. 0.0
- 34. 0.0
- 35. -2.0 -1.5 -2.0
- 36. -1.5
- 37. 1.0

*** SUBJECT NO. 31 ***

A. SUBJECT INFORMATION

- 1.
- 2. 21.0
- 3. N
- 4. CM
- 5. F
- 6. 4.0

B. GROUND INSTRUCTION QUIZ GRADES

- 7. -99.0
- 8. -99.0

C. FLIGHT EVALUATION NO. 1

- 9. 11/20
- 10. MG
- 11. 78.0
- 12. 0.0
- 13. 100.0
- 14. 40.0
- 15. 1.0 1.0 2.0 1.0 0.0
- 16. 1. 0. 3. 1. 1.
- 17. 0. 1. 4. 1. 4. 1. 1. 0. 0.
- 18. 0.5
- 19. 20.0
- 20. 0.8
- 21. 7.0
- 22. 1.0 1.0 1.0
- 23. 1.0

D. FLIGHT EVALUATION NO. 2

- 23. 04/29
- 24. WH
- 25. 80.0
- 26. 0.4
- 27. 140.0
- 28. 45.0
- 29. 0.0 1.0 -1.0 0.0 1.0
- 30. 3. 0. 4. 3. 1.
- 31. 1. 0. 0. 1. 1. 0. 0. 0. 0.
- 32. 1.0
- 33. 21.0
- 34. 4.0
- 35. 5.0
- 36. -1.0 -1.0 -1.0
- 37. 0.0
- 38. -0.5

*** SUBJECT NO. 32 ***

A. SUBJECT INFORMATION

- 1.
- 2. 42.0
- 3. N
- 4. RP
- 5. C
- 6. 4.0

B. GROUND INSTRUCTION QUIZ GRADES

- 7. 11.0
- 8. 16.0

C. FLIGHT EVALUATION NO. 1

- 9. 01/15
- 10. MG
- 11. 24.0
- 12. 0.6
- 13. 40.0
- 14. 1.0
- 15. 0.0 -1.0 -1.0 -1.0 -2.0
- 16. 0. 1. 3. 0. 3. 4. 1. 3. 4.
5. 1. 3. 2. 0.
- 17. -1.0
- 18. 12.0
- 19. 1.4
- 20. 5.0
- 21. -2.0 -1.0 -2.0
- 22. -2.0

D. FLIGHT EVALUATION NO. 2

- 23. 06/08
- 24. KG
- 25. 33.0
- 26. 1.0
- 27. 45.0
- 28. 4.0
- 29. 2.0 2.0 -1.0 2.0 0.0
- 30. 0. 0. 0. 0. 0. 0. 0. 0. 0.
0. 0. 0. 0. 0.
- 31. 0.5
- 32. 12.0
- 33. 3.0
- 34. 4.0
- 35. 0.0 -2.0 0.0
- 36. 1.0
- 37. 2.0

*** SUBJECT NO. 33 ***

A. SUBJECT INFORMATION

- 1.
- 2. 19.0
- 3. P
- 4. BC
- 5. P
- 6. 4.0

B. GROUND INSTRUCTION QUIZ GRADES

- 7. 14.0
- 8. 11.0

C. FLIGHT EVALUATION NO. 1

- 9. 12/11
- 10. MG
- 11. 196.0
- 12. 1.6
- 13. 150.0
- 14. 5.0
- 15. 2.0 2.0 2.0 2.0 2.0
- 16. 3. 0. 5. 1. 1.
0. 0. 0. 0. 1. 0. 0. 0. 0.
- 17. 2.3
- 18. 21.1
- 19. 0.7
- 20. 4.0
- 21. 2.0 2.0 2.0
- 22. 1.0

D. FLIGHT EVALUATION NO. 2

- 23. 04/15
- 24. WH
- 25. 225.0
- 26. 1.9
- 27. 170.0
- 28. 15.0
- 29. 2.0 2.0 2.0 2.0 2.0
- 30. 0. 0. 1. 0. 0.
0. 0. 0. 0. 0. 0. 0. 0. 0.
- 31. 2.0
- 32. 24.0
- 33. 0.0
- 34. 0.0
- 35. 2.0 2.0 2.0
- 36. 2.0
- 37. 1.5

*** SUBJECT NO. 34 ***

A. SUBJECT INFORMATION

1.
2. 22.0
3. N
4.
5. P
6. 1.0

B. GROUND INSTRUCTION QUIZ GRADES

7. 10.0
8. 7.0

C. FLIGHT EVALUATION NO. 1

9. 12/05
10. MG
11. 7.5
12. 0.9
13. 10.0
14. 0.0
15. -1.0 -1.0 -1.0 -1.0 -1.0
16. 5. 1. 9. 2. 6. 9. 0. 1. 0.
0. 1. 2. 0. 6.
17. -1.0
18. 15.0
19. 0.3
20. 3.0
21. -1.0 0.0 -0.5
22. -1.5

D. FLIGHT EVALUATION NO. 2

23. 04/29
24. WH
25. 17.0
26. 0.0
27. 15.0
28. 0.0
29. -2.0 0.0 -1.0 -1.0 -2.0
30. 5. 0. 11. 0. 4. 1. 5. 0. 0.
1. 0. 1. 0. 6.
31. 1.0
32. 22.0
33. 0.8
34. 3.0
35. 0.0 -2.0 -1.0
36. -2.0
37. 0.0

*** SUBJECT NO. 35 ***

A. SUBJECT INFORMATION

- 1.
- 2. 28.0
- 3. N
- 4. BM
- 5. C
- 6. 2.0

B. GROUND INSTRUCTION QUIZ GRADES

- 7. 10.0
- 8. 12.0

C. FLIGHT EVALUATION NO. 1

- 9. 02/03
- 10. MG
- 11. 30.0
- 12. 0.5
- 13. 25.0
- 14. 0.0
- 15. 0.0 -2.0 0.0 -2.0 -1.0
- 16. 0. 0. 1. 1. 1.
- 17. 1. 1. 1. 1. 0. 0. 0. 0. 1.
- 18. 0.5
- 19. 17.3
- 20. 1.6
- 21. 4.0
- 22. 0.5 0.5 0.0
- 23. 0.5

D. FLIGHT EVALUATION NO. 2

- 23. 06/10
- 24. KG
- 25. 34.0
- 26. 0.3
- 27. 30.0
- 28. 0.0
- 29. 2.0 1.0 2.0 1.0 2.0
- 30. 0. 0. 0. 0. 0.
- 31. 0. 0. 0. 0. 0. 0. 0. 0. 0.
- 32. 0.0
- 33. 10.0
- 34. 2.0
- 35. 3.0
- 36. 1.0 1.0 1.0
- 37. 2.0
- 38. 2.0

*** SUBJECT NO. 36 ***

A. SUBJECT INFORMATION

1.
2. 21.0
3. N
4. KK
5. F
6. 2.0

B. GROUND INSTRUCTION QUIZ GRADES

7. 11.0
8. 12.0

C. FLIGHT EVALUATION NO. 1

9. 11/06
10. MG
11. 15.0
12. 1.6
13. 5.0
14. 0.0
15. 0.0 1.0 0.0 0.0 -1.0
16. 2. 0. 6. 0. 2.
0. 1. 1. 0. 3. 5. 1. 0. 0.
17. 1.0
18. 20.0
19. 0.2
20. 2.0
21. 0.0 0.0 0.0
22. 0.0

D. FLIGHT EVALUATION NO. 2

23. 02/26
24. MG
25. 34.0
26. 1.5
27. -99.0
28. 0.0
29. 0.5 1.0 -1.0 0.5 0.5
30. 1. 0. 1. 1. 1.
0. 0. 1. 0. 1. 0. 0. 0. 0.
31. 1.5
32. 21.0
33. 0.5
34. 1.0
35. 1.0 2.0 1.0
36. 2.0
37. 2.0

*** SUBJECT NO. 37 ***

A. SUBJECT INFORMATION

- 1.
- 2. 20.0
- 3. N
- 4. CM
- 5. F
- 6. 2.0

B. GROUND INSTRUCTION QUIZ GRADES

- 7. 12.0
- 8. 14.0

C. FLIGHT EVALUATION NO. 1

- 9. 11/18
- 10. MG
- 11. 64.0
- 12. 0.6
- 13. 20.0
- 14. 0.0
- 15. -1.0 0.0 0.0 0.0 -1.0
- 16. 2. 0. 11. 0. 4.
- 3. 0. 4. 2. 4. 2. 1. 0. 0.
- 17. -1.0
- 18. 19.3
- 19. 0.5
- 20. 4.0
- 21. 1.0 0.0 0.0
- 22. -1.0

D. FLIGHT EVALUATION NO. 2

- 23. 03/12
- 24. MG
- 25. 67.0
- 26. 0.0
- 27. 21.0
- 28. 0.0
- 29. -1.0 0.0 0.0 -1.0 -1.0
- 30. 7. 0. 3. 0. 4.
- 0. 0. 0. 0. 5. 0. 3. 0. 0.
- 31. 1.0
- 32. 18.5
- 33. 0.0
- 34. 0.0
- 35. 1.0 1.0 0.0
- 36. 0.5
- 37. 1.5

*** SUBJECT NO. 38 ***

A. SUBJECT INFORMATION

- 1.
- 2. 19.0
- 3. N
- 4. WH
- 5. P
- 6. 4.0

B. GROUND INSTRUCTION QUIZ GRADES

- 7. 10.0
- 8. 10.0

C. FLIGHT EVALUATION NO. 1

- 9. 11/20
- 10. MG
- 11. 9.0
- 12. 0.9
- 13. 10.0
- 14. 2.0
- 15. -1.0 -1.0 -2.0 0.0 -2.0
- 16. 5. 2. 20. 0. 6.
0. 2. 5. 1. 11. 9. 3. 0. 0.
- 17. -1.0
- 18. 19.0
- 19. 0.2
- 20. 1.0
- 21. -2.0 -2.0 -2.0
- 22. -2.5

D. FLIGHT EVALUATION NO. 2

- 23. 04/15
- 24. WH
- 25. 26.0
- 26. 0.9
- 27. 20.0
- 28. 4.0
- 29. -2.0 -1.0 -2.0 -1.0 -2.0
- 30. 3. 0. 8. 0. 5.
1. 0. 3. 0. 2. 0. 1. 0. 0.
- 31. -1.0
- 32. 18.0
- 33. 2.5
- 34. 2.0
- 35. -2.0 -2.0 -2.0
- 36. -2.0
- 37. 1.5

*** SUBJECT NO. 39 ***

A. SUBJECT INFORMATION

- 1.
- 2. 19.0
- 3. N
- 4. KO
- 5. F
- 6. 3.0

B. GROUND INSTRUCTION QUIZ GRADES

- 7. 12.0
- 8. 12.0

C. FLIGHT EVALUATION NO. 1

- 9. 12/02
- 10. MG
- 11. 31.0
- 12. 3.5
- 13. 50.0
- 14. 2.0
- 15. 2.0 2.0 2.0 2.0 2.0
- 16. 0. 0. 1. 0. 3.
0. 0. 0. 0. 0. 1. 0. 0. 0.
- 17. 0.0
- 18. 21.5
- 19. 0.0
- 20. 0.0
- 21. 0.0 1.0 1.0
- 22. 1.0

D. FLIGHT EVALUATION NO. 2

- 23. 03/12
- 24. MG
- 25. 62.0
- 26. 1.9
- 27. -99.0
- 28. 2.0
- 29. 1.5 1.5 1.5 2.0 1.5
- 30. 0. 0. 1. 2. 2.
0. 1. 0. 0. 1. 0. 2. 0. 0.
- 31. -1.0
- 32. 20.0
- 33. 0.2
- 34. 1.0
- 35. -1.0 0.5 0.0
- 36. 1.0
- 37. 0.0

*** SUBJECT NO. 40 ***

A. SUBJECT INFORMATION

- 1.
- 2. 17.0
- 3. N
- 4. JG
- 5. C
- 6. 2.0

B. GROUND INSTRUCTION QUIZ GRADES

- 7. 12.0
- 8. 14.0

C. FLIGHT EVALUATION NO. 1

- 9. 11/06
- 10. WH
- 11. 41.0
- 12. 2.0
- 13. 55.0
- 14. 0.0
- 15. 1.0 1.0 -1.0 0.0 0.0
- 16. 6. 4. 4. 1. 1. 2. 1. 0. 0.
- 17. 1. 1. 0. 3. 1.
- 18. -1.0
- 19. 22.0
- 20. 0.0
- 21. 0.0
- 22. 1.0 -1.0 1.0
- 23. 1.0

D. FLIGHT EVALUATION NO. 2

- 23. 05/05
- 24. KG
- 25. 68.0
- 26. 1.4
- 27. 65.0
- 28. 0.0
- 29. 3.0 3.0 2.0 1.0 2.0
- 30. 0. 0. 0. 0. 0. 0. 0. 0. 0.
- 31. 0. 0. 0. 0. 0.
- 32. 2.0
- 33. 12.0
- 34. 0.0
- 35. 0.0
- 36. 2.0 2.0 2.0
- 37. 2.5
- 38. 2.0

*** SUBJECT NO. 41 ***

A. SUBJECT INFORMATION

- 1.
- 2. 36.0
- 3. C
- 4. KO
- 5. F
- 6. 4.0

B. GROUND INSTRUCTION QUIZ GRADES

- 7. 6.0
- 8. 14.0

C. FLIGHT EVALUATION NO. 1

- 9. 12/11
- 10. MG
- 11. 204.0
- 12. 0.4
- 13. -99.0
- 14. 3.0
- 15. 0.0 0.0 0.0 0.0 -1.0
- 16. 3. 0. 10. 1. 2. 0. 1. 0. 0.
- 17. 0. 0. 0. 1. 3.
- 18. 1.0
- 19. 19.0
- 20. 1.5
- 21. 9.0
- 22. 0.0 0.0 0.0
- 23. -1.0

D. FLIGHT EVALUATION NO. 2

- 23. 04/13
- 24. MG
- 25. 214.0
- 26. 1.3
- 27. -99.0
- 28. 10.0
- 29. 2.0 2.0 1.0 1.0 2.0
- 30. 6. 0. 8. 0. 0. 0. 0. 0. 0.
- 31. 0. 0. 3. 0. 7.
- 32. 1.0
- 33. 18.0
- 34. 2.4
- 35. 5.0
- 36. 0.5 0.5 0.0
- 37. 0.5
- 38. 1.0

*** SUBJECT NO. 42 ***

A. SUBJECT INFORMATION

- 1.
- 2. 20.0
- 3. A
- 4. JG
- 5. C
- 6. 4.0

B. GROUND INSTRUCTION QUIZ GRADES

- 7. 14.0
- 8. 14.0

C. FLIGHT EVALUATION NO. 1

- 9. 12/13
- 10. WH
- 11. 35.0
- 12. 2.8
- 13. 20.0
- 14. 0.0
- 15. 1.0 1.0 -1.0 1.0 -1.0
- 16. 2. 0. 0. 0. 2.
- 17. 1. 0. 0. 0. 2. 0. 0. 0. 0.
- 18. 0.5
- 19. 17.0
- 20. 0.0
- 21. 0.0 -1.0 1.0
- 22. 1.0

D. FLIGHT EVALUATION NO. 2

- 23. 04/14
- 24. KG
- 25. 65.0
- 26. 2.5
- 27. 40.0
- 28. 4.0
- 29. 3.0 3.0 2.0 2.0 2.0
- 30. 0. 0. 0. 0. 0.
- 31. 0. 0. 0. 0. 0. 0. 0. 0. 0.
- 32. 3.0
- 33. 13.0
- 34. 0.2
- 35. 1.0 -1.0 2.0
- 36. 2.0
- 37. 2.0

*** SUBJECT NO. 43 ***

A. SUBJECT INFORMATION

- 1.
- 2. 24.0
- 3. N
- 4. TM
- 5. C
- 6. 3.0

B. GROUND INSTRUCTION QUIZ GRADES

- 7. 12.0
- 8. 16.0

C. FLIGHT EVALUATION NO. 1

- 9. 12/11
- 10. WN
- 11. 26.0
- 12. 0.3
- 13. 51.0
- 14. 0.0
- 15. 0.0 0.0 -1.0 -1.0 -1.0
- 16. 0. 0. 2. 0. 0.
- 17. 0. 2. 0. 0. 2. 2. 2. 0. 0.
- 18. 0.7
- 19. 18.5
- 20. 0.4
- 21. 2.0
- 22. -1.0 0.0 0.0
- 23. 1.0

D. FLIGHT EVALUATION NO. 2

- 23. 06/04
- 24. KG
- 25. 30.0
- 26. 0.5
- 27. 55.0
- 28. 0.0
- 29. 0.0 0.0 0.0 0.0 0.0
- 30. 1. 0. 1. 0. 2.
- 31. 0. 0. 0. 0. 1. 0. 0. 0. 0.
- 32. 0.5
- 33. 13.0
- 34. 1.5
- 35. 2.0
- 36. -1.0 -1.0 0.0
- 37. 0.0
- 38. 0.0

*** SUBJECT NO. 44 ***

A. SUBJECT INFORMATION

- 1.
- 2. 25.0
- 3. N
- 4. ZR
- 5. C
- 6. 3.0

B. GROUND INSTRUCTION QUIZ GRADES

- 7. 14.0
- 8. 9.0

C. FLIGHT EVALUATION NO. 1

- 9. 02/03
- 10. MG
- 11. 35.0
- 12. 0.6
- 13. 30.0
- 14. 0.0
- 15. 1.5 1.5 1.0 1.5 1.0
- 16. 0. 0. 2. 0. 0.
0. 0. 2. 0. 0. 0. 0. 0. 0.
- 17. 0.5
- 18. 18.5
- 19. 0.0
- 20. 0.0
- 21. 0.5 0.5 1.0
- 22. 1.0

D. FLIGHT EVALUATION NO. 2

- 23. 04/06
- 24. KG
- 25. 42.0
- 26. 0.9
- 27. 40.0
- 28. 0.0
- 29. 2.0 2.0 -1.0 2.0 -1.0
- 30. 0. 0. 0. 0. 0.
0. 0. 0. 0. 0. 0. 0. 0. 0.
- 31. 1.0
- 32. 13.0
- 33. 1.5
- 34. 3.0
- 35. -1.0 2.0 2.0
- 36. 2.0
- 37. 1.0

*** SUBJECT NO. 45 ***

A. SUBJECT INFORMATION

1.
2. 18.0
3. N
4. KG
5. C
6. 3.0

B. GROUND INSTRUCTION QUIZ GRADES

7. 9.0
8. 8.0

C. FLIGHT EVALUATION NO. 1

9. 12/17
10. MG
11. 6.0
12. 0.3
13. 18.0
14. 0.0
15. -2.0 -2.0 -2.0 -2.0 -2.0
16. 0. 0. 5. 1. 0.
17. 5. 2. 3. 0. 0. 5. 1. 3. 3.
18. -1.0
19. 13.3
20. 2.7
21. 3.0
22. -2.5 -2.5 -2.0
23. -2.5

D. FLIGHT EVALUATION NO. 2

23. 05/06
24. KG
25. 25.0
26. 1.9
27. 35.0
28. 0.0
29. -2.0 -2.0 -2.0 -2.0 -2.0
30. 0. 0. 1. 0. 2.
31. 1. 2. 1. 0. 1. 3. 0. 2. 2.
32. -1.3
33. 12.3
34. 0.0
35. 0.0
36. -2.0 -2.0 -2.5
37. -2.0
38. 0.0

*** SUBJECT NO. 46 ***

A. SUBJECT INFORMATION

- 1.
- 2. 20.0
- 3. F
- 4. BM
- 5. C
- 6. 4.0

B. GROUND INSTRUCTION QUIZ GRADES

- 7. 11.0
- 8. 12.0

C. FLIGHT EVALUATION NO. 1

- 9. 01/30
- 10. MG
- 11. 114.0
- 12. 0.5
- 13. 30.0
- 14. 2.0
- 15. 2.0 2.0 1.0 1.0 -1.0
- 16. 0. 0. 0. 0. 0.
- 17. 0. 0. 0. 0. 0. 0. 0. 0. 0.
- 18. 1.0
- 19. 20.3
- 20. 0.3
- 21. 2.0
- 22. 1.0 2.0 2.0
- 23. 2.0

D. FLIGHT EVALUATION NO. 2

- 23. 05/11
- 24. KG
- 25. 125.0
- 26. 1.4
- 27. 40.0
- 28. 6.0
- 29. 2.0 2.0 -1.0 2.0 2.0
- 30. 0. 0. 0. 0. 0.
- 31. 0. 0. 0. 0. 0. 0. 0. 0.
- 32. 1.3
- 33. 13.0
- 34. 0.0
- 35. 0.0
- 36. 1.0 2.0 2.0
- 37. 2.0
- 38. 0.0

*** SUBJECT NO. 47 ***

A. SUBJECT INFORMATION

- 1.
- 2. 23.0
- 3. N
- 4. BC
- 5. P
- 6. 1.0

B. GROUND INSTRUCTION QUIZ GRADES

- 7. 10.0
- 8. -99.0

C. FLIGHT EVALUATION NO. 1

- 9. 11/19
- 10. MG
- 11. 62.0
- 12. 0.9
- 13. 150.0
- 14. 0.0
- 15. -99.0 -1.0 -1.0 -1.0 1.0
- 16. 1. 0. 4. 0. 1.
0. 0. 1. 3. 4. 3. 1. 0. 0.
- 17. 0.0
- 18. 22.0
- 19. 0.7
- 20. 6.0
- 21. 0.0 1.0 1.0
- 22. 0.0

D. FLIGHT EVALUATION NO. 2

- 23. 05/06
- 24. WH
- 25. 78.0
- 26. 0.3
- 27. 155.0
- 28. 0.0
- 29. -1.0 1.0 1.0 0.0 -1.0
- 30. 3. 0. 5. 0. 2.
0. 0. 0. 2. 3. 0. 3. 0. 0.
- 31. 1.5
- 32. 27.0
- 33. 0.8
- 34. 2.0
- 35. 0.0 -1.0 1.0
- 36. 0.0
- 37. 0.0

*** SUBJECT NO. 48 ***

A. SUBJECT INFORMATION

- 1.
- 2. -99.0
- 3. N
- 4. CN
- 5. C
- 6. 4.0

B. GROUND INSTRUCTION QUIZ GRADES

- 7. 8.0
- 8. 10.0

C. FLIGHT EVALUATION NO. 1

- 9. 12/12
- 10. WN
- 11. 81.0
- 12. 1.9
- 13. 56.0
- 14. 2.0
- 15. 0.0 0.0 1.0 1.0 0.0
- 16. 0. 1. 8. 0. 6.
- 17. 0. 0. 8. 0. 1. 12. 0. 4. 0.
- 18. -1.5
- 19. 22.0
- 20. 0.4
- 21. 2.0
- 22. -1.0 1.0 1.0
- 23. -2.0

D. FLIGHT EVALUATION NO. 2

- 23. 05/21
- 24. RF
- 25. 95.0
- 26. 0.6
- 27. 65.0
- 28. 6.0
- 29. -99.0 -99.0 -99.0 -99.0 -99.0
- 30. 0. 0. 0. 0. 0.
- 31. 0. 0. 0. 0. 0. 0. 0. 0. 0.
- 32. -1.0
- 33. 5.5
- 34. 1.0
- 35. 3.0
- 36. 0.0 1.0 1.0
- 37. 0.0
- 38. 1.0

*** SUBJECT NO. 49 ***

A. SUBJECT INFORMATION

1.
2. 20.0
3. N
4. CN
5. C
6. 4.0

B. GROUND INSTRUCTION QUIZ GRADES

7. 12.0
8. 11.0

C. FLIGHT EVALUATION NO. 1

9. 12/13
10. WH
11. 17.2
12. 1.4
13. 24.0
14. 0.0
15. 1.0 -1.5 -1.0 -1.0 0.0
16. 2. 0. 0. 1. 1. 0. 0. 0. 0.
1. 0. 0. 0. 1. 0. 0. 0. 0.
17. -0.5
18. 20.0
19. 1.4
20. 4.0
21. -1.0 -1.0 0.0
22. 1.0

D. FLIGHT EVALUATION NO. 2

23. 05/21
24. KG
25. 25.0
26. 1.0
27. 35.0
28. 4.0
29. 1.0 -99.0 -99.0 -99.0 -99.0
30. 0. 0. 0. 0. 0. 0. 0. 0. 0.
0. 0. 0. 0. 0. 0. 0. 0. 0.
31. 0.0
32. 12.3
33. 0.0
34. 0.0
35. 0.0 0.0 -1.0
36. 1.0
37. 0.0

*** SUBJECT NO. 50 ***

A. SUBJECT INFORMATION

- 1.
- 2. 19.0
- 3. N
- 4. JG
- 5. C
- 6. 1.0

B. GROUND INSTRUCTION QUIZ GRADES

- 7. 11.0
- 8. 8.0

C. FLIGHT EVALUATION NO. 1

- 9. 12/19
- 10. WH
- 11. 14.0
- 12. 1.3
- 13. 20.0
- 14. 0.0
- 15. -3.0 -3.0 -3.0 -3.0 -3.0
- 16. -99. -99. -99. -99. -99.
-99. -99. -99. -99. -99. -99. -99. -99.
- 17. -99.0
- 18. 10.0
- 19. 5.0
- 20. -99.0
- 21. -3.0 -3.0 -3.0
- 22. -3.0

D. FLIGHT EVALUATION NO. 2

- 23. 05/06
- 24. KG
- 25. 26.0
- 26. 1.7
- 27. 30.0
- 28. 0.0
- 29. 0.0 -2.0 1.0 -2.0 -2.0
- 30. -99. -99. -99. -99. -99.
-99. -99. -99. -99. -99. -99. -99. -99.
- 31. -1.0
- 32. 10.0
- 33. 1.2
- 34. 2.0
- 35. -1.0 -2.0 -1.0
- 36. -2.0
- 37. 3.0

*** SUBJECT NO. 51 ***

A. SUBJECT INFORMATION

- 1.
- 2. 41.0
- 3. N
- 4. BM
- 5. C
- 6. 2.0

B. GROUND INSTRUCTION QUIZ GRADES

- 7. 7.0
- 8. 13.0

C. FLIGHT EVALUATION NO. 1

- 9. 11/06
- 10. WH
- 11. 24.0
- 12. 0.7
- 13. 32.0
- 14. 1.0
- 15. -1.0 0.0 -1.0 -1.0 -1.0
- 16. 4. 0. 6. 2. 7.
- 0. 1. 12. 0. 1. 11. 0. 2. 3.
- 17. 0.0
- 18. 16.0
- 19. 0.6
- 20. 2.0
- 21. -2.0 -2.0 -2.0
- 22. -3.0

D. FLIGHT EVALUATION NO. 2

- 23. 04/07
- 24. KG
- 25. 30.0
- 26. 0.9
- 27. 35.0
- 28. 3.0
- 29. -2.0 -2.0 -2.0 -3.0 -1.0
- 30. 4. 0. 4. 0. 5.
- 0. 0. 0. 0. 2. 8. 3. 3. 3.
- 31. -0.5
- 32. 12.0
- 33. 1.0
- 34. 1.0
- 35. -2.0 -3.0 -2.0
- 36. -3.0
- 37. 0.0

*** SUBJECT NO. 52 ***

A. SUBJECT INFORMATION

1.
2. 26.0
3. N
4. TM
5. C
6. 4.0

B. GROUND INSTRUCTION QUIZ GRADES

7. 14.0
8. 10.0

C. FLIGHT EVALUATION NO. 1

9. 11/06
10. WH
11. 75.0
12. 1.3
13. 56.0
14. 3.0
15. -1.0 -1.0 -1.0 -1.0 -1.0
16. 0. 0. 4. 1. 2.
0. 2. 0. 0. 5. 4. 4. 0. 0.
17. 1.0
18. 14.0
19. 2.3
20. 2.0
21. -1.0 -1.0 0.0
22. -1.0

D. FLIGHT EVALUATION NO. 2

23. 06/11
24. KG
25. 120.0
26. 4.0
27. 65.0
28. 6.0
29. 0.0 -1.0 0.0 -1.0 0.0
30. 0. 0. 3. 0. 0.
0. 0. 0. 0. 0. 0. 0. 0. 0. 0.
31. 1.5
32. 10.6
33. 1.1
34. 2.0
35. 0.0 0.0 0.0
36. 0.0
37. 1.0

*** SUBJECT NO. 53 ***

A. SUBJECT INFORMATION

- 1.
- 2. 17.0
- 3. P
- 4. CM
- 5. P
- 6. 4.0

B. GROUND INSTRUCTION QUIZ GRADES

- 7. 12.0
- 8. 16.0

C. FLIGHT EVALUATION NO. 1

- 9. 12/02
- 10. MG
- 11. 167.0
- 12. 7.6
- 13. 200.0
- 14. 20.0
- 15. 2.0 1.0 2.0 2.0 2.0
- 16. 0. 0. 0. 0. 0. 0. 0. 0. 0.
- 17. 1.5
- 18. 19.0
- 19. 0.2
- 20. 1.0
- 21. 2.0 2.0 2.0
- 22. 2.0

D. FLIGHT EVALUATION NO. 2

- 23. 02/26
- 24. MG
- 25. 221.0
- 26. 5.6
- 27. -99.0
- 28. 25.0
- 29. 2.0 2.0 1.0 2.0 2.0
- 30. 0. 0. 0. 0. 1. 0. 0. 0. 0.
- 31. 2.0
- 32. 19.0
- 33. 0.8
- 34. 3.0
- 35. 2.0 2.0 1.0
- 36. 2.0
- 37. 0.0

*** SUBJECT NO. 54 ***

A. SUBJECT INFORMATION

- 1.
- 2. 20.0
- 3. N
- 4. KK
- 5. P
- 6. 2.0

B. GROUND INSTRUCTION QUIZ GRADES

- 7. 8.0
- 8. 11.0

C. FLIGHT EVALUATION NO. 1

- 9. 12/03
- 10. MG
- 11. 43.7
- 12. 2.1
- 13. 50.0
- 14. 0.0
- 15. 1.0 1.0 0.0 0.0 0.0
- 16. 11. 0. 14. 0. 11. 4. 3. 0. 0.
- 17. 0. 1. 3. 3. 6.
- 17. -1.0
- 18. 20.0
- 19. 0.6
- 20. 4.0
- 21. 0.0 0.0 0.0
- 22. -1.0

D. FLIGHT EVALUATION NO. 2

- 23. 03/06
- 24. WH
- 25. 62.0
- 26. 1.5
- 27. -99.0
- 28. 0.0
- 29. 1.0 1.0 1.0 1.0 -99.0
- 30. 3. 0. 6. 0. 1. 0. 0. 2. 1.
- 31. 1. 2. 1. 0. 1.
- 31. 0.0
- 32. 20.0
- 33. 0.2
- 34. 1.0
- 35. 1.0 1.0 1.0
- 36. 0.0
- 37. 1.0

*** SUBJECT NO. 55 ***

A. SUBJECT INFORMATION

- 1.
- 2. 15.0
- 3. N
- 4. TM
- 5. C
- 6. 3.0

B. GROUND INSTRUCTION QUIZ GRADES

- 7. 11.0
- 8. 13.0

C. FLIGHT EVALUATION NO. 1

- 9. 12/17
- 10. MG
- 11. 75.0
- 12. 0.0
- 13. 20.0
- 14. 0.0
- 15. 2.0 2.0 2.0 2.0 2.0
- 16. 0. 0. 0. 1. 0.
0. 0. 0. 0. 0. 0. 0. 0. 0. 0.
- 17. 0.0
- 18. 24.0
- 19. 0.2
- 20. 1.0
- 21. 1.0 2.0 1.0
- 22. 2.0

D. FLIGHT EVALUATION NO. 2

- 23. 05/06
- 24. KG
- 25. 78.0
- 26. 0.3
- 27. 30.0
- 28. 0.0
- 29. 2.0 2.0 1.0 1.5 2.0
- 30. 0. 0. 0. 0. 0.
0. 0. 0. 0. 0. 0. 0. 0. 0. 0.
- 31. 1.7
- 32. 14.0
- 33. 1.0
- 34. 1.0
- 35. 1.0 2.0 2.0
- 36. 2.0
- 37. 1.0

*** SUBJECT NO. 56 ***

A. SUBJECT INFORMATION

- 1.
- 2. 19.0
- 3. P
- 4. CM
- 5. P
- 6. 3.0

B. GROUND INSTRUCTION QUIZ GRADES

- 7. 16.0
- 8. 16.0

C. FLIGHT EVALUATION NO. 1

- 9. 12/03
- 10. MG
- 11. 134.0
- 12. 4.2
- 13. 100.0
- 14. 2.0
- 15. 1.0 0.0 0.0 -1.0 0.0
- 16. 4. 0. 4. 0. 6. 3. 2. 0. 0.
- 17. 2. 2. 0. 1. 4.
- 18. 0.0
- 19. 19.0
- 20. 0.8
- 21. 7.0
- 22. 0.0 -1.0 0.0
- 23. 0.0

D. FLIGHT EVALUATION NO. 2

- 23. 03/06
- 24. WH
- 25. 160.0
- 26. 1.9
- 27. -99.0
- 28. 2.0
- 29. 1.0 1.0 0.0 0.0 0.0
- 30. 1. 0. 0. 0. 4. 0. 0. 0. 0.
- 31. 0. 0. 0. 1. 1.
- 32. 0.0
- 33. 20.0
- 34. 0.7
- 35. 4.0
- 36. 1.0 0.0 0.0
- 37. 0.0
- 38. 0.5

*** SUBJECT NO. 57 ***

A. SUBJECT INFORMATION

- 1.
- 2. 28.0
- 3. N
- 4. CM
- 5. F
- 6. 4.0

B. GROUND INSTRUCTION QUIZ GRADES

- 7. -99.0
- 8. -99.0

C. FLIGHT EVALUATION NO. 1

- 9. 11/07
- 10. MG
- 11. 11.0
- 12. 1.4
- 13. 10.0
- 14. 0.0
- 15. 0.0 0.0 0.0 0.0 -1.0
- 16. 1. 3. 4. 0. 7.
0. 0. 0. 0. 7. 10. 6. 0. 0.
- 17. -1.0
- 18. 18.0
- 19. 0.1
- 20. 1.0
- 21. -1.0 -1.0 0.0
- 22. -1.0

D. FLIGHT EVALUATION NO. 2

- 23. /
- 24.
- 25. -99.0
- 26. -99.0
- 27. -99.0
- 28. -99.0
- 29. -99.0 -99.0 -99.0 -99.0 -99.0
- 30. -99. -99. -99. -99. -99.
-99. -99. -99. -99. -99. -99. -99. -99.
- 31. -99.0
- 32. -99.0
- 33. -99.0
- 34. -99.0
- 35. -99.0 -99.0 -99.0
- 36. -99.0
- 37. -99.0

*** SUBJECT NO. 58 ***

A. SUBJECT INFORMATION

- 1.
- 2. 19.0
- 3. P
- 4. KO
- 5. P
- 6. 4.0

B. GROUND INSTRUCTION QUIZ GRADES

- 7. 14.0
- 8. 14.0

C. FLIGHT EVALUATION NO. 1

- 9. 11/06
- 10. MG
- 11. 155.0
- 12. 3.1
- 13. 350.0
- 14. 4.0
- 15. 2.0 2.0 2.0 2.0 2.0
- 16. 3. 0. 1. 0. 4. 0. 0. 0. 0.
- 0. 0. 0. 0. 3.
- 17. 2.0
- 18. 19.0
- 19. 0.2
- 20. 2.0
- 21. 1.5 2.0 1.5
- 22. 1.5

D. FLIGHT EVALUATION NO. 2

- 23. 03/09
- 24. MG
- 25. 192.0
- 26. 1.8
- 27. -99.0
- 28. 11.0
- 29. 2.0 2.0 2.0 2.0 2.0
- 30. 1. 0. 1. 1. 1. 0. 0. 0. 0.
- 0. 0. 0. 0. 1.
- 31. 2.0
- 32. 16.0
- 33. 0.4
- 34. 2.0
- 35. 1.5 2.0 2.0
- 36. 1.5
- 37. 0.0

*** SUBJECT NO. 59 ***

A. SUBJECT INFORMATION

- 1.
- 2. 17.0
- 3. F
- 4. RP
- 5. C
- 6. 3.0

B. GROUND INSTRUCTION QUIZ GRADES

- 7. 14.0
- 8. 16.0

C. FLIGHT EVALUATION NO. 1

- 9. 12/18
- 10. WH
- 11. 120.0
- 12. 1.9
- 13. 70.0
- 14. 5.0
- 15. 0.0 0.0 -1.0 0.0 -1.0
- 16. 0. 0. 0. 0. 0.
- 0. 0. 0. 0. 0. 0. 0. 0.
- 17. 0.0
- 18. 25.0
- 19. 1.2
- 20. 5.0
- 21. -1.0 -1.0 0.0
- 22. 1.0

D. FLIGHT EVALUATION NO. 2

- 23. 05/06
- 24. KG
- 25. 145.0
- 26. 2.0
- 27. 85.0
- 28. 9.0
- 29. 0.0 0.0 -1.0 0.0 1.0
- 30. 0. 0. 0. 0. 0.
- 0. 2. 1. 0. 2. 1. 0. 2. 0.
- 31. 0.5
- 32. 11.0
- 33. 1.4
- 34. 3.0
- 35. 0.0 0.0 1.0
- 36. 1.0
- 37. 1.0

*** SUBJECT NO. 60 ***

A. SUBJECT INFORMATION

1.
2. 18.0
3. N
4. WH
5. F
6. 4.0

B. GROUND INSTRUCTION QUIZ GRADES

7. 14.0
8. 16.0

C. FLIGHT EVALUATION NO. 1

9. 11/07
10. MG
11. 6.0
12. 0.8
13. 10.0
14. 1.0
15. 2.0 2.0 2.0 1.0 2.0
16. 0. 0. 1. 0. 1. 1. 1. 1. 0.
17. 0. 1. 1. 0. 1.
18. 1.0
19. 21.0
20. 0.2
21. 1.0
22. 2.0 2.0 2.0

D. FLIGHT EVALUATION NO. 2

23. 05/06
24. WH
25. 38.0
26. 0.2
27. 60.0
28. 6.0
29. -2.0 0.0 -1.0 0.0 0.0
30. 5. 0. 4. 0. 9. 0. 3. 0. 0.
31. 12. 0. 2. 0. 3.
32. 1.0
33. 23.0
34. 1.0
35. 3.0
36. 0.0 -1.0 -1.0
37. -1.0
38. -1.0

*** SUBJECT NO. 61 ***

A. SUBJECT INFORMATION

- 1.
- 2. 22.0
- 3. N
- 4. BC
- 5. F
- 6. 3.0

B. GROUND INSTRUCTION QUIZ GRADES

- 7. 15.0
- 8. 15.0

C. FLIGHT EVALUATION NO. 1

- 9. 12/03
- 10. MG
- 11. 64.0
- 12. 1.8
- 13. 28.0
- 14. 1.0
- 15. 1.0 -1.0 0.0 -1.0 -1.0
- 16. 8. 0. 5. 2. 5.
0. 0. 0. 2. 3. 3. 0. 0. 0.
- 17. 0.0
- 18. 21.0
- 19. 0.2
- 20. 2.0
- 21. 0.0 0.0 0.0
- 22. 0.5

D. FLIGHT EVALUATION NO. 2

- 23. 04/29
- 24. WH
- 25. 135.0
- 26. 4.3
- 27. 40.0
- 28. 4.0
- 29. 0.0 1.0 1.0 -1.0 2.0
- 30. 1. 0. 2. 0. 0.
0. 0. 0. 0. 1. 0. 0. 0. 0.
- 31. 1.0
- 32. 25.0
- 33. 0.2
- 34. 1.0
- 35. 1.0 -1.0 -1.0
- 36. 2.0
- 37. 2.0

*** SUBJECT NO. 62 ***

A. SUBJECT INFORMATION

- 1.
- 2. 20.0
- 3. P
- 4. CM
- 5. P
- 6. 4.0

B. GROUND INSTRUCTION QUIZ GRADES

- 7. 14.0
- 8. 17.0

C. FLIGHT EVALUATION NO. 1

- 9. 12/03
- 10. MG
- 11. 99.0
- 12. 0.3
- 13. 100.0
- 14. 1.0
- 15. 1.0 1.0 1.0 2.0 2.0
- 16. 3. 0. 2. 2. 5. 1. 0. 0. 0.
- 17. 0. 0. 0. 0. 4.
- 18. 1.0
- 19. 17.0
- 20. 1.1
- 21. 8.0
- 22. 0.0 0.0 0.0

D. FLIGHT EVALUATION NO. 2

- 23. 04/08
- 24. WH
- 25. 113.0
- 26. 1.1
- 27. 115.0
- 28. 7.0
- 29. 0.0 1.0 1.0 0.0 0.0
- 30. 5. 0. 6. 0. 1. 0. 2. 0. 0.
- 31. 0. 0. 0. 0. 1.
- 32. 0.5
- 33. 23.0
- 34. 0.2
- 35. 1.0
- 36. 1.0 1.0 0.0
- 37. 0.0
- 38. 1.0

APPENDIX D

SUMMARY STATISTICS OF STALL AWARENESS RESULTS

This appendix summarizes the statistics of experimental results obtained during the study. It presents the mean, standard deviation, minimum value and maximum value for each of the observed variables, except 1-5 defined in Table 5 of the report. This data is presented for the subjects population as a whole (Group 0), and also broken down for each of the four training groups:

Group 1 - Control - no additional training

Group 2 - Additional ground school only

Group 3 - Additional ground school and stall avoidance practices

Group 4 - Additional ground school, stall avoidance practice, and spin training

The number of observations (i.e., subjects) for each variable and group is also shown.

| <u>Variable</u> | <u>Training Group</u> | <u>No Pts.</u> | <u>Mean</u> | <u>Standard Deviation</u> | <u>Minimum Value</u> | <u>Maximum Value</u> |
|-----------------|-----------------------|----------------|-------------|---------------------------|----------------------|----------------------|
| 6 | 0 | 58 | 22.22 | 6.289 | 15.00 | 45.00 |
| 6 | 1 | 11 | 21.18 | 2.786 | 18.00 | 28.00 |
| 6 | 2 | 9 | 24.44 | 8.202 | 17.00 | 41.00 |
| 6 | 3 | 17 | 19.94 | 3.071 | 15.00 | 27.00 |
| 6 | 4 | 21 | 23.67 | 8.058 | 16.00 | 45.00 |
| 7 | 0 | 62 | 1.306 | 0.5892 | 1.000 | 3.000 |
| 7 | 1 | 11 | 1.273 | 0.6467 | 1.000 | 3.000 |
| 7 | 2 | 11 | 1.455 | 0.6876 | 1.000 | 3.000 |
| 7 | 3 | 18 | 1.278 | 0.5745 | 1.000 | 3.000 |
| 7 | 4 | 22 | 1.273 | 0.5505 | 1.000 | 3.000 |
| 8 | 0 | 62 | 52.47 | 51.73 | 5.000 | 204.0 |
| 8 | 1 | 11 | 17.89 | 18.72 | 5.000 | 62.00 |
| 8 | 2 | 11 | 50.75 | 44.50 | 15.00 | 170.0 |
| 8 | 3 | 18 | 52.59 | 44.63 | 5.800 | 144.0 |
| 8 | 4 | 22 | 70.51 | 63.90 | 6.000 | 204.0 |
| 9 | 0 | 61 | 1.390 | 1.278 | 0.0000 | 7.600 |
| 9 | 1 | 11 | 0.9782 | 0.6489 | 0.0000 | 2.400 |
| 9 | 2 | 11 | 1.541 | 1.222 | 0.3200 | 4.200 |
| 9 | 3 | 18 | 1.339 | 1.156 | 0.0000 | 4.200 |
| 9 | 4 | 21 | 1.572 | 1.633 | 0.0000 | 7.600 |
| 10 | 0 | 60 | 47.43 | 58.69 | 0.0000 | 350.0 |
| 10 | 1 | 11 | 37.91 | 44.06 | 5.000 | 150.0 |
| 10 | 2 | 11 | 41.09 | 55.18 | 0.0000 | 200.0 |
| 10 | 3 | 17 | 36.59 | 23.04 | 10.00 | 100.0 |
| 10 | 4 | 21 | 64.52 | 82.25 | 3.000 | 350.0 |
| 11 | 0 | 61 | 1.738 | 5.738 | 0.0000 | 40.00 |
| 11 | 1 | 11 | 0.0000 | 0.0000 | 0.0000 | 0.0000 |
| 11 | 2 | 11 | 0.1818 | 0.4045 | 0.0000 | 1.000 |
| 11 | 3 | 18 | 0.8333 | 1.654 | 0.0000 | 5.000 |
| 11 | 4 | 21 | 4.238 | 9.278 | 0.0000 | 40.00 |
| 12 | 0 | 51 | 2.490 | 1.377 | 1.000 | 5.000 |
| 12 | 1 | 10 | 1.900 | 1.197 | 1.000 | 4.000 |
| 12 | 2 | 9 | 2.111 | 1.453 | 1.000 | 4.000 |
| 12 | 3 | 14 | 2.714 | 1.383 | 1.000 | 4.000 |
| 12 | 4 | 18 | 2.833 | 1.383 | 1.000 | 5.000 |

| <u>Variable</u> | <u>Training Group</u> | <u>No Pts.</u> | <u>Mean</u> | <u>Standard Deviation</u> | <u>Minimum Value</u> | <u>Maximum Value</u> |
|-----------------|-----------------------|----------------|-------------|---------------------------|----------------------|----------------------|
| 13 | 0 | 51 | 72.72 | 59.44 | 14.00 | 225.0 |
| 13 | 1 | 10 | 30.36 | 18.91 | 14.00 | 78.00 |
| 13 | 2 | 9 | 64.33 | 53.32 | 25.00 | 199.0 |
| 13 | 3 | 14 | 71.86 | 46.83 | 25.00 | 160.0 |
| 13 | 4 | 18 | 101.1 | 72.40 | 24.00 | 225.0 |
| 14 | 0 | 51 | 1.344 | 1.081 | 0.0000 | 5.600 |
| 14 | 1 | 10 | 0.9050 | 0.7704 | 0.0000 | 2.600 |
| 14 | 2 | 9 | 1.042 | 0.6886 | 0.0000 | 2.160 |
| 14 | 3 | 14 | 1.592 | 0.9936 | 0.3000 | 4.300 |
| 14 | 4 | 18 | 1.546 | 1.375 | 0.2000 | 5.600 |
| 15 | 0 | 32 | 53.00 | 39.41 | 15.00 | 170.0 |
| 15 | 1 | 4 | 58.75 | 64.73 | 15.00 | 155.0 |
| 15 | 2 | 5 | 34.40 | 18.13 | 21.00 | 65.00 |
| 15 | 3 | 9 | 41.56 | 18.76 | 20.00 | 85.00 |
| 15 | 4 | 14 | 65.36 | 44.96 | 20.00 | 170.0 |
| 16 | 0 | 51 | 4.039 | 7.660 | 0.0000 | 45.00 |
| 16 | 1 | 10 | 0.0000 | 0.0000 | 0.0000 | 0.0000 |
| 16 | 2 | 9 | 0.4444 | 1.014 | 0.0000 | 3.000 |
| 16 | 3 | 14 | 1.571 | 2.709 | 0.0000 | 9.000 |
| 16 | 4 | 18 | 10.00 | 10.36 | 4.000 | 45.00 |
| 17 | 0 | 61 | 0.2213 | 1.250 | -3.000 | 2.500 |
| 17 | 1 | 10 | -0.7000 | 1.160 | -3.000 | 1.000 |
| 17 | 2 | 11 | -0.1818 | 0.9816 | -2.000 | 1.000 |
| 17 | 3 | 18 | 0.3611 | 1.109 | -2.000 | 2.000 |
| 17 | 4 | 22 | 0.7273 | 1.288 | -2.500 | 2.500 |
| 18 | 0 | 62 | 0.2419E-01 | 1.239 | -3.000 | 2.500 |
| 18 | 1 | 11 | -0.7273 | 1.009 | -3.000 | 1.000 |
| 18 | 2 | 11 | -0.9091E-01 | 1.221 | -2.000 | 1.000 |
| 18 | 3 | 18 | 0.8333E-01 | 1.141 | -2.000 | 2.000 |
| 18 | 4 | 22 | 0.4091 | 1.324 | -2.000 | 2.500 |
| 19 | 0 | 62 | -0.1532 | 1.260 | -3.000 | 2.500 |
| 19 | 1 | 11 | -0.6364 | 1.120 | -3.000 | 1.000 |
| 19 | 2 | 11 | -0.4545 | 0.9342 | -2.000 | 1.000 |
| 19 | 3 | 18 | -0.2222 | 1.215 | -2.000 | 2.000 |
| 19 | 4 | 22 | 0.2955 | 1.420 | -2.000 | 2.500 |

| <u>Variable</u> | <u>Training Group</u> | <u>No Pts.</u> | <u>Mean</u> | <u>Standard Deviation</u> | <u>Minimum Value</u> | <u>Maximum Value</u> |
|-----------------|-----------------------|----------------|-------------|---------------------------|----------------------|----------------------|
| 20 | 0 | 62 | -0.1855 | 1.265 | -3.000 | 2.500 |
| 20 | 1 | 11 | -0.8182 | 1.079 | -3.000 | 1.000 |
| 20 | 2 | 11 | -0.8182 | 1.250 | -3.000 | 1.000 |
| 20 | 3 | 18 | -0.1667 | 1.138 | -2.000 | 2.000 |
| 20 | 4 | 22 | 0.4318 | 1.218 | -2.000 | 2.500 |
| | | | | | | |
| 21 | 0 | 61 | -0.2049 | 1.346 | -3.000 | 2.500 |
| 21 | 1 | 11 | -0.8182 | 1.168 | -3.000 | 1.000 |
| 21 | 2 | 10 | -0.5000 | 0.8498 | -2.000 | 1.000 |
| 21 | 3 | 18 | -0.1667 | 1.339 | -2.000 | 2.000 |
| 21 | 4 | 22 | 0.2045 | 1.533 | -2.000 | 2.500 |
| | | | | | | |
| 22 | 0 | 61 | 2.066 | 2.442 | 0.0000 | 11.00 |
| 22 | 1 | 10 | 3.100 | 2.331 | 0.0000 | 7.000 |
| 22 | 2 | 11 | 2.818 | 3.371 | 0.0000 | 11.00 |
| 22 | 3 | 18 | 1.889 | 2.632 | 0.0000 | 8.000 |
| 22 | 4 | 22 | 1.364 | 1.529 | 0.0000 | 5.000 |
| | | | | | | |
| 23 | 0 | 61 | 0.3934 | 0.9179 | 0.0000 | 4.000 |
| 23 | 1 | 10 | 1.100 | 1.287 | 0.0000 | 3.000 |
| 23 | 2 | 11 | 0.3636 | 1.206 | 0.0000 | 4.000 |
| 23 | 3 | 18 | 0.0000 | 0.0000 | 0.0000 | 0.0000 |
| 23 | 4 | 22 | 0.4091 | 0.7964 | 0.0000 | 3.000 |
| | | | | | | |
| 24 | 0 | 61 | 4.180 | 4.500 | 0.0000 | 20.00 |
| 24 | 1 | 10 | 6.000 | 4.546 | 1.000 | 16.00 |
| 24 | 2 | 11 | 5.818 | 5.269 | 0.0000 | 15.00 |
| 24 | 3 | 18 | 3.056 | 2.920 | 0.0000 | 10.00 |
| 24 | 4 | 22 | 3.455 | 4.925 | 0.0000 | 20.00 |
| | | | | | | |
| 25 | 0 | 61 | 0.6721 | 0.9078 | 0.0000 | 3.000 |
| 25 | 1 | 10 | 0.9000 | 1.287 | 0.0000 | 3.000 |
| 25 | 2 | 11 | 0.7273 | 0.7862 | 0.0000 | 2.000 |
| 25 | 3 | 18 | 0.8889 | 1.023 | 0.0000 | 3.000 |
| 25 | 4 | 22 | 0.3636 | 0.5811 | 0.0000 | 2.000 |
| | | | | | | |
| 26 | 0 | 61 | 2.689 | 3.009 | 0.0000 | 13.00 |
| 26 | 1 | 10 | 3.300 | 3.889 | 0.0000 | 13.00 |
| 26 | 2 | 11 | 3.091 | 3.448 | 0.0000 | 11.00 |
| 26 | 3 | 18 | 2.444 | 2.833 | 0.0000 | 10.00 |
| 26 | 4 | 22 | 2.409 | 2.612 | 0.0000 | 9.000 |

| <u>Variable</u> | <u>Training Group</u> | <u>No Pts.</u> | <u>Mean</u> | <u>Standard Deviation</u> | <u>Minimum Value</u> | <u>Maximum Value</u> |
|-----------------|-----------------------|----------------|-------------|---------------------------|----------------------|----------------------|
| 27 | 0 | 61 | 1.082 | 3.132 | 0.0000 | 18.00 |
| 27 | 1 | 10 | 0.7000 | 1.636 | 0.0000 | 5.000 |
| 27 | 2 | 11 | 0.6364 | 1.027 | 0.0000 | 3.000 |
| 27 | 3 | 18 | 1.500 | 4.301 | 0.0000 | 18.00 |
| 27 | 4 | 22 | 1.136 | 3.328 | 0.0000 | 15.00 |
| | | | | | | |
| 28 | 0 | 61 | 0.5902 | 0.8637 | 0.0000 | 3.000 |
| 28 | 1 | 10 | 0.8000 | 0.9189 | 0.0000 | 2.000 |
| 28 | 2 | 11 | 1.000 | 1.095 | 0.0000 | 3.000 |
| 28 | 3 | 18 | 0.5556 | 0.8556 | 0.0000 | 2.000 |
| 28 | 4 | 22 | 0.3182 | 0.6463 | 0.0000 | 2.000 |
| | | | | | | |
| 29 | 0 | 61 | 1.426 | 2.276 | 0.0000 | 12.00 |
| 29 | 1 | 10 | 1.800 | 2.201 | 0.0000 | 6.000 |
| 29 | 2 | 11 | 2.636 | 3.529 | 0.0000 | 12.00 |
| 29 | 3 | 18 | 0.9444 | 1.211 | 0.0000 | 4.000 |
| 29 | 4 | 22 | 1.045 | 2.104 | 0.0000 | 8.000 |
| | | | | | | |
| 30 | 0 | 61 | 0.7377 | 1.377 | 0.0000 | 7.000 |
| 30 | 1 | 10 | 1.200 | 1.814 | 0.0000 | 5.000 |
| 30 | 2 | 11 | 0.9091 | 1.221 | 0.0000 | 3.000 |
| 30 | 3 | 18 | 0.6111 | 0.9785 | 0.0000 | 3.000 |
| 30 | 4 | 22 | 0.5455 | 1.535 | 0.0000 | 7.000 |
| | | | | | | |
| 31 | 0 | 61 | 2.574 | 2.735 | 0.0000 | 11.00 |
| 31 | 1 | 10 | 4.200 | 2.974 | 0.0000 | 9.000 |
| 31 | 2 | 11 | 2.273 | 2.054 | 0.0000 | 6.000 |
| 31 | 3 | 18 | 2.167 | 2.684 | 0.0000 | 9.000 |
| 31 | 4 | 22 | 2.318 | 2.868 | 0.0000 | 11.00 |
| | | | | | | |
| 32 | 0 | 61 | 2.836 | 3.348 | 0.0000 | 12.00 |
| 32 | 1 | 10 | 4.400 | 3.950 | 0.0000 | 11.00 |
| 32 | 2 | 11 | 2.909 | 3.208 | 0.0000 | 11.00 |
| 32 | 3 | 18 | 2.333 | 2.567 | 0.0000 | 9.000 |
| 32 | 4 | 22 | 2.500 | 3.687 | 0.0000 | 12.00 |
| | | | | | | |
| 33 | 0 | 61 | 1.033 | 1.602 | 0.0000 | 7.000 |
| 33 | 1 | 10 | 2.300 | 2.312 | 0.0000 | 7.000 |
| 33 | 2 | 11 | 1.091 | 1.300 | 0.0000 | 3.000 |
| 33 | 3 | 18 | 0.5556 | 0.9835 | 0.0000 | 3.000 |
| 33 | 4 | 22 | 0.8182 | 1.563 | 0.0000 | 6.000 |

| <u>Variable</u> | <u>Training Group</u> | <u>No Pts.</u> | <u>Mean</u> | <u>Standard Deviation</u> | <u>Minimum Value</u> | <u>Maximum Value</u> |
|-----------------|-----------------------|----------------|-------------|---------------------------|----------------------|----------------------|
| 34 | 0 | 61 | 0.3115 | 0.8275 | 0.0000 | 4.000 |
| 34 | 1 | 10 | 0.2000 | 0.4216 | 0.0000 | 1.000 |
| 34 | 2 | 11 | 0.1818 | 0.6030 | 0.0000 | 2.000 |
| 34 | 3 | 18 | 0.3333 | 0.8402 | 0.0000 | 3.000 |
| 34 | 4 | 22 | 0.4091 | 1.054 | 0.0000 | 4.000 |
| 35 | 0 | 61 | 0.2295 | 0.7614 | 0.0000 | 4.000 |
| 35 | 1 | 10 | 0.1000 | 0.3162 | 0.0000 | 1.000 |
| 35 | 2 | 11 | 0.3636 | 0.9244 | 0.0000 | 3.000 |
| 35 | 3 | 18 | 0.2222 | 0.7321 | 0.0000 | 3.000 |
| 35 | 4 | 22 | 0.2273 | 0.8691 | 0.0000 | 4.000 |
| 36 | 0 | 57 | 0.3596E-01 | 0.9562 | -2.000 | 2.250 |
| 36 | 1 | 8 | -0.8125 | 0.8425 | -2.000 | 0.0000 |
| 36 | 2 | 11 | -0.1364 | 0.6360 | -1.000 | 1.000 |
| 36 | 3 | 18 | 0.2667 | 0.5388 | -1.000 | 1.500 |
| 36 | 4 | 20 | 0.2625 | 1.239 | -2.000 | 2.250 |
| 37 | 0 | 62 | 185.6 | 34.46 | 100.0 | 253.0 |
| 37 | 1 | 11 | 173.4 | 40.17 | 100.0 | 230.0 |
| 37 | 2 | 11 | 190.9 | 33.82 | 120.0 | 253.0 |
| 37 | 3 | 18 | 188.0 | 39.47 | 110.0 | 253.0 |
| 37 | 4 | 22 | 187.1 | 27.85 | 120.0 | 220.0 |
| 38 | 0 | 60 | 10.15 | 12.82 | 0.0000 | 60.00 |
| 38 | 1 | 11 | 10.79 | 14.06 | 0.8000 | 50.00 |
| 38 | 2 | 11 | 8.264 | 10.36 | 0.0000 | 36.00 |
| 38 | 3 | 17 | 13.50 | 17.90 | 0.0000 | 60.00 |
| 38 | 4 | 21 | 8.100 | 7.742 | 0.0000 | 26.00 |
| 39 | 0 | 60 | 64.83 | 98.96 | 0.0000 | 500.0 |
| 39 | 1 | 11 | 80.44 | 142.3 | 4.170 | 500.0 |
| 39 | 2 | 11 | 54.33 | 86.00 | 0.0000 | 300.0 |
| 39 | 3 | 17 | 84.99 | 122.2 | 0.0000 | 440.0 |
| 39 | 4 | 21 | 45.84 | 46.84 | 0.0000 | 166.4 |
| 40 | 0 | 58 | 3.328 | 3.263 | 0.0000 | 20.00 |
| 40 | 1 | 10 | 3.100 | 1.969 | 1.000 | 7.000 |
| 40 | 2 | 10 | 2.400 | 1.776 | 0.0000 | 5.000 |
| 40 | 3 | 17 | 4.294 | 4.674 | 0.0000 | 20.00 |
| 40 | 4 | 21 | 3.095 | 2.897 | 0.0000 | 9.000 |

| <u>Variable</u> | <u>Training Group</u> | <u>No Pts.</u> | <u>Mean</u> | <u>Standard Deviation</u> | <u>Minimum Value</u> | <u>Maximum Value</u> |
|-----------------|-----------------------|----------------|-------------|---------------------------|----------------------|----------------------|
| 41 | 0 | 58 | 191.3 | 229.3 | 0.0000 | 1600. |
| 41 | 1 | 10 | 173.3 | 109.8 | 58.82 | 411.8 |
| 41 | 2 | 10 | 127.4 | 97.48 | 0.0000 | 273.2 |
| 41 | 3 | 17 | 266.4 | 366.0 | 0.0000 | 1600. |
| 41 | 4 | 21 | 169.5 | 159.4 | 0.0000 | 473.7 |
| | | | | | | |
| 42 | 0 | 61 | -0.2459 | 1.340 | -3.000 | 2.500 |
| 42 | 1 | 11 | -0.6364 | 1.206 | -3.000 | 1.000 |
| 42 | 2 | 11 | -0.1818 | 1.383 | -2.000 | 2.000 |
| 42 | 3 | 17 | -0.4118 | 1.337 | -2.500 | 2.000 |
| 42 | 4 | 22 | 0.4545E-01 | 1.405 | -2.000 | 2.500 |
| | | | | | | |
| 43 | 0 | 61 | -0.2869 | 1.404 | -3.000 | 2.500 |
| 43 | 1 | 11 | -0.6364 | 1.206 | -3.000 | 1.000 |
| 43 | 2 | 11 | -0.5455 | 1.387 | -3.000 | 1.500 |
| 43 | 3 | 17 | -0.4118 | 1.383 | -2.500 | 2.000 |
| 43 | 4 | 22 | 0.1136 | 1.511 | -2.000 | 2.500 |
| | | | | | | |
| 44 | 0 | 61 | -0.9836E-01 | 1.363 | -3.000 | 2.500 |
| 44 | 1 | 11 | -0.4091 | 1.281 | -3.000 | 1.000 |
| 44 | 2 | 11 | -0.5000 | 1.360 | -3.000 | 1.500 |
| 44 | 3 | 17 | -0.2941 | 1.263 | -2.000 | 2.000 |
| 44 | 4 | 22 | 0.4091 | 1.411 | -2.000 | 2.500 |
| | | | | | | |
| 45 | 0 | 62 | -0.6452E-01 | 1.505 | -3.000 | 2.500 |
| 45 | 1 | 11 | -0.7727 | 1.148 | -3.000 | 1.000 |
| 45 | 2 | 11 | -0.4545 | 1.524 | -3.000 | 2.000 |
| 45 | 3 | 18 | 0.5556E-01 | 1.514 | -2.500 | 2.500 |
| 45 | 4 | 22 | 0.3864 | 1.558 | -2.500 | 2.500 |
| | | | | | | |
| 46 | 0 | 49 | 0.5510 | 1.494 | -2.000 | 3.000 |
| 46 | 1 | 9 | -0.3333 | 1.118 | -2.000 | 1.000 |
| 46 | 2 | 9 | 0.7222 | 1.563 | -2.000 | 3.000 |
| 46 | 3 | 14 | 0.2143 | 1.355 | -2.000 | 2.000 |
| 46 | 4 | 17 | 1.206 | 1.532 | -2.000 | 3.000 |
| | | | | | | |
| 47 | 0 | 48 | 0.6458 | 1.376 | -2.000 | 3.000 |
| 47 | 1 | 9 | -0.3889 | 1.112 | -2.000 | 1.500 |
| 47 | 2 | 9 | 0.7778 | 1.394 | -2.000 | 3.000 |
| 47 | 3 | 14 | 0.3571 | 1.262 | -2.000 | 2.000 |
| 47 | 4 | 16 | 1.406 | 1.228 | -1.000 | 3.000 |

| <u>Variable</u> | <u>Training Group</u> | <u>No Pts.</u> | <u>Mean</u> | <u>Standard Deviation</u> | <u>Minimum Value</u> | <u>Maximum Value</u> |
|-----------------|-----------------------|----------------|-------------|---------------------------|----------------------|----------------------|
| 48 | 0 | 48 | 0.2500 | 1.376 | -2.000 | 3.000 |
| 48 | 1 | 9 | 0.2222 | 0.9391 | -1.000 | 1.500 |
| 48 | 2 | 9 | 0.4444 | 1.509 | -2.000 | 2.000 |
| 48 | 3 | 14 | -0.2500 | 1.252 | -2.000 | 1.500 |
| 48 | 4 | 16 | 0.5937 | 1.583 | -2.000 | 3.000 |
| | | | | | | |
| 49 | 0 | 48 | 0.2604 | 1.360 | -3.000 | 2.500 |
| 49 | 1 | 9 | -0.5000 | 1.000 | -2.000 | 1.500 |
| 49 | 2 | 9 | 0.1667 | 1.541 | -3.000 | 2.000 |
| 49 | 3 | 14 | 0.0000 | 1.401 | -2.000 | 2.000 |
| 49 | 4 | 16 | 0.9687 | 1.161 | -1.000 | 2.500 |
| | | | | | | |
| 50 | 0 | 47 | 0.2979 | 1.506 | -2.000 | 3.000 |
| 50 | 1 | 9 | -0.7778 | 1.302 | -2.000 | 2.000 |
| 50 | 2 | 8 | 0.5625 | 1.400 | -1.000 | 2.000 |
| 50 | 3 | 14 | 0.3571E-01 | 1.393 | -2.000 | 2.000 |
| 50 | 4 | 16 | 1.000 | 1.461 | -2.000 | 3.000 |
| | | | | | | |
| 51 | 0 | 50 | 1.740 | 2.088 | 0.0000 | 7.000 |
| 51 | 1 | 9 | 2.222 | 2.048 | 0.0000 | 5.000 |
| 51 | 2 | 9 | 2.444 | 2.186 | 0.0000 | 7.000 |
| 51 | 3 | 14 | 1.571 | 2.065 | 0.0000 | 6.000 |
| 51 | 4 | 18 | 1.278 | 2.109 | 0.0000 | 6.000 |
| | | | | | | |
| 52 | 0 | 50 | 0.0000 | 0.0000 | 0.0000 | 0.0000 |
| 52 | 1 | 9 | 0.0000 | 0.0000 | 0.0000 | 0.0000 |
| 52 | 2 | 9 | 0.0000 | 0.0000 | 0.0000 | 0.0000 |
| 52 | 3 | 14 | 0.0000 | 0.0000 | 0.0000 | 0.0000 |
| 52 | 4 | 18 | 0.0000 | 0.0000 | 0.0000 | 0.0000 |
| | | | | | | |
| 53 | 0 | 50 | 2.300 | 2.830 | 0.0000 | 11.00 |
| 53 | 1 | 9 | 3.778 | 3.114 | 0.0000 | 11.00 |
| 53 | 2 | 9 | 1.889 | 2.088 | 0.0000 | 6.000 |
| 53 | 3 | 14 | 2.071 | 2.999 | 0.0000 | 10.00 |
| 53 | 4 | 18 | 1.944 | 2.859 | 0.0000 | 8.000 |
| | | | | | | |
| 54 | 0 | 50 | 0.3600 | 0.8514 | 0.0000 | 3.000 |
| 54 | 1 | 9 | 0.3333 | 0.7071 | 0.0000 | 2.000 |
| 54 | 2 | 9 | 1.000 | 1.323 | 0.0000 | 3.000 |
| 54 | 3 | 14 | 0.1429 | 0.5345 | 0.0000 | 2.000 |
| 54 | 4 | 18 | 0.2222 | 0.7321 | 0.0000 | 3.000 |

| <u>Variable</u> | <u>Training Group</u> | <u>No Pts.</u> | <u>Mean</u> | <u>Standard Deviation</u> | <u>Minimum Value</u> | <u>Maximum Value</u> |
|-----------------|-----------------------|----------------|-------------|---------------------------|----------------------|----------------------|
| 55 | 0 | 50 | 1.720 | 2.080 | 0.0000 | 9.000 |
| 55 | 1 | 9 | 2.667 | 1.732 | 0.0000 | 5.000 |
| 55 | 2 | 9 | 2.111 | 1.833 | 0.0000 | 5.000 |
| 55 | 3 | 14 | 1.786 | 1.968 | 0.0000 | 6.000 |
| 55 | 4 | 18 | 1.000 | 2.326 | 0.0000 | 9.000 |
| | | | | | | |
| 56 | 0 | 50 | 0.5200 | 1.832 | 0.0000 | 12.00 |
| 56 | 1 | 9 | 0.8889 | 1.537 | 0.0000 | 4.000 |
| 56 | 2 | 9 | 0.1111 | 0.3333 | 0.0000 | 1.000 |
| 56 | 3 | 14 | 0.2143 | 0.5789 | 0.0000 | 2.000 |
| 56 | 4 | 18 | 0.7778 | 2.819 | 0.0000 | 12.00 |
| | | | | | | |
| 57 | 0 | 50 | 0.1800 | 0.5226 | 0.0000 | 2.000 |
| 57 | 1 | 9 | 0.1111 | 0.3333 | 0.0000 | 1.000 |
| 57 | 2 | 9 | 0.2222 | 0.6667 | 0.0000 | 2.000 |
| 57 | 3 | 14 | 0.4286 | 0.7559 | 0.0000 | 2.000 |
| 57 | 4 | 18 | 0.0000 | 0.0000 | 0.0000 | 0.0000 |
| | | | | | | |
| 58 | 0 | 50 | 0.5400 | 0.9304 | 0.0000 | 4.000 |
| 58 | 1 | 9 | 0.6667 | 0.7071 | 0.0000 | 2.000 |
| 58 | 2 | 9 | 0.3333 | 0.5000 | 0.0000 | 1.000 |
| 58 | 3 | 14 | 0.7143 | 1.139 | 0.0000 | 4.000 |
| 58 | 4 | 18 | 0.4444 | 1.042 | 0.0000 | 3.000 |
| | | | | | | |
| 59 | 0 | 50 | 0.2800 | 0.6074 | 0.0000 | 2.000 |
| 59 | 1 | 9 | 0.7778 | 0.8333 | 0.0000 | 2.000 |
| 59 | 2 | 9 | 0.2222 | 0.6667 | 0.0000 | 2.000 |
| 59 | 3 | 14 | 0.2857 | 0.6112 | 0.0000 | 2.000 |
| 59 | 4 | 18 | 0.5556E-01 | 0.2357 | 0.0000 | 1.000 |
| | | | | | | |
| 60 | 0 | 50 | 1.740 | 1.998 | 0.0000 | 8.000 |
| 60 | 1 | 9 | 3.667 | 2.398 | 0.0000 | 8.000 |
| 60 | 2 | 9 | 1.889 | 1.616 | 0.0000 | 5.000 |
| 60 | 3 | 14 | 1.500 | 1.506 | 0.0000 | 4.000 |
| 60 | 4 | 18 | 0.8889 | 1.745 | 0.0000 | 7.000 |
| | | | | | | |
| 61 | 0 | 50 | 0.4600 | 1.403 | 0.0000 | 8.000 |
| 61 | 1 | 9 | 0.3333 | 0.5000 | 0.0000 | 1.000 |
| 61 | 2 | 9 | 1.111 | 2.667 | 0.0000 | 8.000 |
| 61 | 3 | 14 | 0.7143 | 1.490 | 0.0000 | 5.000 |
| 61 | 4 | 18 | 0.0000 | 0.0000 | 0.0000 | 0.0000 |

| <u>Variable</u> | <u>Training Group</u> | <u>No Pts.</u> | <u>Mean</u> | <u>Standard Deviation</u> | <u>Minimum Value</u> | <u>Maximum Value</u> |
|-----------------|-----------------------|----------------|-------------|---------------------------|----------------------|----------------------|
| 62 | 0 | 50 | 0.7400 | 1.291 | 0.0000 | 5.000 |
| 62 | 1 | 9 | 1.444 | 1.667 | 0.0000 | 5.000 |
| 62 | 2 | 9 | 0.7778 | 1.302 | 0.0000 | 3.000 |
| 62 | 3 | 14 | 0.7857 | 1.424 | 0.0000 | 5.000 |
| 62 | 4 | 18 | 0.3333 | 0.8402 | 0.0000 | 3.000 |
| 63 | 0 | 50 | 0.2000 | 0.6389 | 0.0000 | 3.000 |
| 63 | 1 | 9 | 0.1111 | 0.3333 | 0.0000 | 1.000 |
| 63 | 2 | 9 | 0.5556 | 1.130 | 0.0000 | 3.000 |
| 63 | 3 | 14 | 0.2857 | 0.7263 | 0.0000 | 2.000 |
| 63 | 4 | 18 | 0.0000 | 0.0000 | 0.0000 | 0.0000 |
| 64 | 0 | 50 | 0.1400 | 0.5349 | 0.0000 | 3.000 |
| 64 | 1 | 9 | 0.1111 | 0.3333 | 0.0000 | 1.000 |
| 64 | 2 | 9 | 0.4444 | 1.014 | 0.0000 | 3.000 |
| 64 | 3 | 14 | 0.1429 | 0.5345 | 0.0000 | 2.000 |
| 64 | 4 | 18 | 0.0000 | 0.0000 | 0.0000 | 0.0000 |
| 65 | 0 | 45 | 0.6867 | 1.042 | -1.300 | 3.000 |
| 65 | 1 | 7 | 0.2857 | 0.8092 | -1.000 | 1.500 |
| 65 | 2 | 8 | 0.4375 | 1.016 | -1.000 | 2.000 |
| 65 | 3 | 13 | 0.4923 | 0.9323 | -1.300 | 1.700 |
| 65 | 4 | 17 | 1.118 | 1.144 | -1.000 | 3.000 |
| 66 | 0 | 50 | 164.0 | 51.40 | 50.00 | 270.0 |
| 66 | 1 | 10 | 172.3 | 67.45 | 50.00 | 270.0 |
| 66 | 2 | 9 | 170.4 | 43.77 | 100.0 | 210.0 |
| 66 | 3 | 13 | 160.4 | 43.66 | 110.0 | 250.0 |
| 66 | 4 | 18 | 158.8 | 53.47 | 55.00 | 240.0 |
| 67 | 0 | 51 | 8.878 | 9.752 | 0.0000 | 40.00 |
| 67 | 1 | 10 | 10.74 | 9.062 | 0.0000 | 33.80 |
| 67 | 2 | 9 | 4.078 | 6.876 | 0.0000 | 20.00 |
| 67 | 3 | 14 | 8.914 | 8.255 | 0.0000 | 25.00 |
| 67 | 4 | 18 | 10.22 | 12.07 | 0.0000 | 40.00 |
| 68 | 0 | 50 | 70.42 | 108.8 | 0.0000 | 676.0 |
| 68 | 1 | 10 | 113.0 | 200.4 | 0.0000 | 676.0 |
| 68 | 2 | 9 | 35.07 | 67.56 | 0.0000 | 200.0 |
| 68 | 3 | 13 | 61.61 | 58.86 | 0.0000 | 157.9 |
| 68 | 4 | 18 | 70.78 | 80.58 | 0.0000 | 250.0 |

| <u>Variable</u> | <u>Training Group</u> | <u>No Pts.</u> | <u>Mean</u> | <u>Standard Deviation</u> | <u>Minimum Value</u> | <u>Maximum Value</u> |
|-----------------|-----------------------|----------------|-------------|---------------------------|----------------------|----------------------|
| 69 | 0 | 51 | 2.059 | 2.024 | 0.0000 | 10.00 |
| 69 | 1 | 10 | 3.300 | 2.669 | 0.0000 | 10.00 |
| 69 | 2 | 9 | 0.6667 | 1.000 | 0.0000 | 3.000 |
| 69 | 3 | 14 | 2.286 | 1.978 | 0.0000 | 6.000 |
| 69 | 4 | 18 | 1.889 | 1.676 | 0.0000 | 5.000 |
| 70 | 0 | 50 | 163.2 | 292.5 | 0.0000 | 2000. |
| 70 | 1 | 10 | 336.8 | 589.3 | 0.0000 | 2000. |
| 70 | 2 | 9 | 53.44 | 97.47 | 0.0000 | 300.0 |
| 70 | 3 | 13 | 143.2 | 131.9 | 0.0000 | 421.0 |
| 70 | 4 | 18 | 136.0 | 144.2 | 0.0000 | 545.5 |
| 71 | 0 | 51 | 0.1765 | 1.165 | -2.000 | 2.000 |
| 71 | 1 | 10 | -0.1000 | 0.9944 | -1.000 | 2.000 |
| 71 | 2 | 9 | 0.5556 | 1.509 | -2.000 | 2.000 |
| 71 | 3 | 14 | -0.2143 | 1.051 | -2.000 | 1.000 |
| 71 | 4 | 18 | 0.4444 | 1.110 | -2.000 | 2.000 |
| 72 | 0 | 51 | -0.2941E-01 | 1.412 | -3.000 | 2.000 |
| 72 | 1 | 10 | -1.000 | 0.9428 | -2.000 | 0.0000 |
| 72 | 2 | 9 | 0.3889 | 1.654 | -3.000 | 2.000 |
| 72 | 3 | 14 | -0.2500 | 1.282 | -2.000 | 2.000 |
| 72 | 4 | 18 | 0.4722 | 1.377 | -2.000 | 2.000 |
| 73 | 0 | 51 | 0.6863E-01 | 1.296 | -2.500 | 2.000 |
| 73 | 1 | 10 | -0.8000 | 0.9189 | -2.000 | 1.000 |
| 73 | 2 | 9 | 0.2222 | 1.394 | -2.000 | 2.000 |
| 73 | 3 | 14 | -0.1071 | 1.212 | -2.500 | 2.000 |
| 73 | 4 | 18 | 0.6111 | 1.290 | -2.000 | 2.000 |
| 74 | 0 | 51 | 0.4118 | 1.410 | -3.000 | 2.500 |
| 74 | 1 | 10 | -0.4500 | 0.9560 | -2.000 | 1.000 |
| 74 | 2 | 9 | 0.6667 | 1.871 | -3.000 | 2.500 |
| 74 | 3 | 14 | 0.2143 | 1.369 | -2.000 | 2.000 |
| 74 | 4 | 18 | 0.9167 | 1.228 | -2.000 | 2.500 |
| 75 | 0 | 57 | 10.81 | 2.844 | 3.000 | 16.00 |
| 75 | 1 | 10 | 8.600 | 2.591 | 3.000 | 12.00 |
| 75 | 2 | 10 | 10.50 | 2.991 | 6.000 | 16.00 |
| 75 | 3 | 17 | 11.41 | 2.623 | 7.000 | 16.00 |
| 75 | 4 | 20 | 11.55 | 2.665 | 6.000 | 14.00 |

| <u>Variable</u> | <u>Training Group</u> | <u>No Pts.</u> | <u>Mean</u> | <u>Standard Deviation</u> | <u>Minimum Value</u> | <u>Maximum Value</u> |
|-----------------|-----------------------|----------------|-------------|---------------------------|----------------------|----------------------|
| 76 | 0 | 56 | 11.98 | 3.084 | 4.000 | 17.00 |
| 76 | 1 | 9 | 7.778 | 2.224 | 4.000 | 12.00 |
| 76 | 2 | 10 | 11.80 | 2.251 | 7.000 | 14.00 |
| 76 | 3 | 17 | 13.12 | 2.804 | 8.000 | 17.00 |
| 76 | 4 | 20 | 13.00 | 2.406 | 10.00 | 17.00 |
| 77 | 0 | 51 | 0.8431 | 0.8631 | -1.000 | 3.000 |
| 77 | 1 | 10 | 0.6000 | 0.9661 | 0.0000 | 3.000 |
| 77 | 2 | 9 | 1.278 | 0.8333 | 0.0000 | 2.000 |
| 77 | 3 | 14 | 0.8571 | 0.7449 | 0.0000 | 2.000 |
| 77 | 4 | 18 | 0.7500 | 0.8952 | -1.000 | 2.000 |
| 78 | 0 | 48 | 0.3542 | 1.353 | -4.000 | 3.000 |
| 78 | 1 | 8 | 0.8750 | 1.356 | -1.000 | 3.000 |
| 78 | 2 | 9 | 0.8333 | 1.173 | -1.000 | 2.000 |
| 78 | 3 | 14 | -0.1786 | 0.8903 | -2.000 | 1.500 |
| 78 | 4 | 17 | 0.2941 | 1.649 | -4.000 | 3.000 |
| 79 | 0 | 48 | 0.5833 | 1.235 | -2.000 | 3.000 |
| 79 | 1 | 9 | 0.5000 | 1.061 | -1.000 | 2.000 |
| 79 | 2 | 9 | 0.7778 | 1.641 | -2.000 | 3.000 |
| 79 | 3 | 14 | 0.3214 | 0.9728 | -2.000 | 2.000 |
| 79 | 4 | 16 | 0.7500 | 1.342 | -2.000 | 3.000 |
| 80 | 0 | 48 | 0.4062 | 1.515 | -3.000 | 4.000 |
| 80 | 1 | 9 | 1.222 | 1.372 | -0.5000 | 4.000 |
| 80 | 2 | 9 | 0.7778 | 1.394 | -1.000 | 3.000 |
| 80 | 3 | 14 | 0.3571E-01 | 1.009 | -2.000 | 2.000 |
| 80 | 4 | 16 | 0.6250E-01 | 1.879 | -3.000 | 3.000 |
| 81 | 0 | 48 | 0.3854 | 1.281 | -3.000 | 4.000 |
| 81 | 1 | 9 | 0.5000 | 0.9354 | -1.000 | 2.000 |
| 81 | 2 | 9 | 0.9444 | 1.878 | -2.000 | 4.000 |
| 81 | 3 | 14 | 0.1071 | 1.059 | -3.000 | 1.500 |
| 81 | 4 | 16 | 0.2500 | 1.238 | -2.000 | 3.000 |
| 82 | 0 | 47 | 0.6277 | 1.596 | -2.500 | 4.000 |
| 82 | 1 | 9 | 0.3333 | 1.414 | -2.000 | 3.000 |
| 82 | 2 | 8 | 1.188 | 1.132 | 0.0000 | 3.000 |
| 82 | 3 | 14 | 0.3929 | 1.243 | -2.000 | 3.000 |
| 82 | 4 | 16 | 0.7187 | 2.129 | -2.500 | 4.000 |

| <u>Variable</u> | <u>Training Group</u> | <u>No Pts.</u> | <u>Mean</u> | <u>Standard Deviation</u> | <u>Minimum Value</u> | <u>Maximum Value</u> |
|-----------------|-----------------------|----------------|-------------|---------------------------|----------------------|----------------------|
| 83 | 0 | 50 | -0.5800 | 2.749 | -8.000 | 5.000 |
| 83 | 1 | 9 | -1.222 | 3.114 | -5.000 | 4.000 |
| 83 | 2 | 9 | -1.000 | 4.031 | -8.000 | 5.000 |
| 83 | 3 | 14 | -0.5714 | 2.533 | -7.000 | 4.000 |
| 83 | 4 | 18 | -0.5556E-01 | 2.014 | -3.000 | 5.000 |
| 84 | 0 | 50 | -0.3800 | 0.9234 | -4.000 | 0.0000 |
| 84 | 1 | 9 | -1.222 | 1.302 | -3.000 | 0.0000 |
| 84 | 2 | 9 | -0.4444 | 1.333 | -4.000 | 0.0000 |
| 84 | 3 | 14 | 0.0000 | 0.0000 | 0.0000 | 0.0000 |
| 84 | 4 | 18 | -0.2222 | 0.5483 | -2.000 | 0.0000 |
| 85 | 0 | 50 | -2.280 | 3.764 | -13.00 | 4.000 |
| 85 | 1 | 9 | -2.778 | 4.684 | -13.00 | 2.000 |
| 85 | 2 | 9 | -4.889 | 4.137 | -13.00 | 0.0000 |
| 85 | 3 | 14 | -1.500 | 2.103 | -5.000 | 1.000 |
| 85 | 4 | 18 | -1.333 | 3.726 | -12.00 | 4.000 |
| 86 | 0 | 50 | -0.4200 | 1.180 | -3.000 | 2.000 |
| 86 | 1 | 9 | -0.6667 | 1.225 | -3.000 | 1.000 |
| 86 | 2 | 9 | 0.1111 | 1.269 | -2.000 | 2.000 |
| 86 | 3 | 14 | -0.8571 | 1.351 | -3.000 | 2.000 |
| 86 | 4 | 18 | -0.2222 | 0.8782 | -2.000 | 2.000 |
| 87 | 0 | 50 | -1.140 | 3.130 | -12.00 | 8.000 |
| 87 | 1 | 9 | -1.000 | 4.637 | -12.00 | 4.000 |
| 87 | 2 | 9 | -1.667 | 3.354 | -10.00 | 2.000 |
| 87 | 3 | 14 | -1.071 | 2.495 | -5.000 | 3.000 |
| 87 | 4 | 18 | -1.000 | 2.808 | -6.000 | 8.000 |
| 88 | 0 | 50 | -0.4800 | 3.436 | -18.00 | 12.00 |
| 88 | 1 | 9 | 0.1111 | 2.315 | -5.000 | 4.000 |
| 88 | 2 | 9 | -0.6667 | 1.225 | -3.000 | 1.000 |
| 88 | 3 | 14 | -1.643 | 4.893 | -18.00 | 2.000 |
| 88 | 4 | 18 | 0.2222 | 3.264 | -5.000 | 12.00 |
| 89 | 0 | 50 | -0.4600 | 0.9733 | -3.000 | 2.000 |
| 89 | 1 | 9 | -0.7778 | 1.093 | -2.000 | 1.000 |
| 89 | 2 | 9 | -0.6667 | 1.118 | -3.000 | 1.000 |
| 89 | 3 | 14 | -0.2143 | 1.122 | -2.000 | 2.000 |
| 89 | 4 | 18 | -0.3889 | 0.6978 | -2.000 | 0.0000 |

| <u>Variable</u> | <u>Training Group</u> | <u>No Pts.</u> | <u>Mean</u> | <u>Standard Deviation</u> | <u>Minimum Value</u> | <u>Maximum Value</u> |
|-----------------|-----------------------|----------------|-------------|---------------------------|----------------------|----------------------|
| 90 | 0 | 50 | -1.100 | 2.435 | -12.00 | 3.000 |
| 90 | 1 | 9 | -1.333 | 1.871 | -4.000 | 1.000 |
| 90 | 2 | 9 | -2.889 | 3.723 | -12.00 | 0.0000 |
| 90 | 3 | 14 | -0.2857 | 1.139 | -2.000 | 2.000 |
| 90 | 4 | 18 | -0.7222 | 2.347 | -8.000 | 3.000 |
| 91 | 0 | 50 | -0.4200 | 1.263 | -5.000 | 2.000 |
| 91 | 1 | 9 | -0.5556 | 2.007 | -5.000 | 2.000 |
| 91 | 2 | 9 | -0.8889 | 1.616 | -3.000 | 2.000 |
| 91 | 3 | 14 | -0.2857 | 1.139 | -3.000 | 2.000 |
| 91 | 4 | 18 | -0.2222 | 0.5483 | -2.000 | 0.0000 |
| 92 | 0 | 50 | -1.000 | 2.770 | -9.000 | 8.000 |
| 92 | 1 | 9 | -0.8889 | 4.197 | -6.000 | 8.000 |
| 92 | 2 | 9 | -0.8889 | 1.965 | -5.000 | 1.000 |
| 92 | 3 | 14 | -1.000 | 2.320 | -5.000 | 2.000 |
| 92 | 4 | 18 | -1.111 | 2.805 | -9.000 | 4.000 |
| 93 | 0 | 50 | -2.480 | 3.072 | -12.00 | 1.000 |
| 93 | 1 | 9 | -4.556 | 3.812 | -11.00 | 0.0000 |
| 93 | 2 | 9 | -2.111 | 1.691 | -5.000 | 0.0000 |
| 93 | 3 | 14 | -2.071 | 2.401 | -9.000 | 1.000 |
| 93 | 4 | 18 | -1.944 | 3.438 | -12.00 | 0.0000 |
| 94 | 0 | 50 | -0.3200 | 1.953 | -7.000 | 5.000 |
| 94 | 1 | 9 | -1.111 | 3.408 | -7.000 | 5.000 |
| 94 | 2 | 9 | -0.2222 | 2.048 | -3.000 | 3.000 |
| 94 | 3 | 14 | 0.7143E-01 | 1.328 | -2.000 | 2.000 |
| 94 | 4 | 18 | -0.2778 | 1.320 | -4.000 | 2.000 |
| 95 | 0 | 50 | -0.1600 | 0.9116 | -4.000 | 2.000 |
| 95 | 1 | 9 | -0.1111 | 0.3333 | -1.000 | 0.0000 |
| 95 | 2 | 9 | 0.3333 | 0.7071 | 0.0000 | 2.000 |
| 95 | 3 | 14 | -0.7143E-01 | 0.8287 | -2.000 | 2.000 |
| 95 | 4 | 18 | -0.5000 | 1.150 | -4.000 | 0.0000 |
| 96 | 0 | 50 | -0.1200 | 0.6273 | -4.000 | 1.000 |
| 96 | 1 | 9 | 0.0000 | 0.0000 | 0.0000 | 0.0000 |
| 96 | 2 | 9 | 0.0000 | 0.5000 | -1.000 | 1.000 |
| 96 | 3 | 14 | -0.7143E-01 | 0.2673 | -1.000 | 0.0000 |
| 96 | 4 | 18 | -0.2778 | 0.9583 | -4.000 | 0.0000 |

| <u>Variable</u> | <u>Training Group</u> | <u>No Pts.</u> | <u>Mean</u> | <u>Standard Deviation</u> | <u>Minimum Value</u> | <u>Maximum Value</u> |
|-----------------|-----------------------|----------------|-------------|---------------------------|----------------------|----------------------|
| 97 | 0 | 42 | 0.6048 | 0.9380 | -1.000 | 3.000 |
| 97 | 1 | 5 | 1.400 | 0.6519 | 0.5000 | 2.000 |
| 97 | 2 | 8 | 0.6250 | 1.356 | -1.000 | 3.000 |
| 97 | 3 | 13 | 0.3577 | 0.7974 | -1.000 | 1.700 |
| 97 | 4 | 16 | 0.5469 | 0.8107 | -0.5000 | 2.500 |
| | | | | | | |
| 98 | 0 | 50 | -21.94 | 54.08 | -165.0 | 88.30 |
| 98 | 1 | 10 | 4.630 | 53.39 | -75.00 | 88.30 |
| 98 | 2 | 9 | -26.78 | 41.40 | -100.0 | 12.00 |
| 98 | 3 | 13 | -28.96 | 53.33 | -140.0 | 40.00 |
| 98 | 4 | 18 | -29.22 | 59.88 | -165.0 | 60.00 |
| | | | | | | |
| 99 | 0 | 49 | -1.141 | 15.99 | -56.70 | 31.70 |
| 99 | 1 | 10 | -0.8000 | 16.53 | -38.00 | 28.00 |
| 99 | 2 | 9 | -1.378 | 5.142 | -11.70 | 4.200 |
| 99 | 3 | 13 | -6.392 | 23.12 | -56.70 | 15.00 |
| 99 | 4 | 17 | 2.800 | 12.66 | -14.20 | 31.70 |
| | | | | | | |
| 100 | 0 | 48 | 14.68 | 133.8 | -380.0 | 629.6 |
| 100 | 1 | 10 | 25.98 | 244.9 | -380.0 | 629.6 |
| 100 | 2 | 9 | 5.146 | 49.07 | -63.93 | 108.7 |
| 100 | 3 | 12 | -7.539 | 126.3 | -299.3 | 115.4 |
| 100 | 4 | 17 | 28.77 | 77.08 | -71.00 | 161.4 |
| | | | | | | |
| 101 | 0 | 48 | -1.292 | 3.494 | -17.00 | 7.000 |
| 101 | 1 | 9 | 0.3333 | 3.317 | -4.000 | 7.000 |
| 101 | 2 | 9 | -1.778 | 1.787 | -5.000 | 0.0000 |
| 101 | 3 | 13 | -2.308 | 5.122 | -17.00 | 3.000 |
| 101 | 4 | 17 | -1.118 | 2.571 | -7.000 | 2.000 |
| | | | | | | |
| 102 | 0 | 47 | -2.541 | 307.6 | -427.1 | 1760. |
| 102 | 1 | 9 | 173.9 | 608.7 | -198.6 | 1760. |
| 102 | 2 | 9 | -77.25 | 110.2 | -273.2 | 68.79 |
| 102 | 3 | 12 | -41.89 | 178.8 | -371.0 | 230.8 |
| 102 | 4 | 17 | -28.62 | 190.2 | -427.1 | 454.5 |
| | | | | | | |
| 103 | 0 | 50 | 0.4500 | 1.031 | -2.000 | 3.000 |
| 103 | 1 | 10 | 0.7000 | 1.252 | -1.000 | 3.000 |
| 103 | 2 | 9 | 0.6111 | 0.6972 | 0.0000 | 2.000 |
| 103 | 3 | 13 | 0.4615 | 1.108 | -1.500 | 3.000 |
| 103 | 4 | 18 | 0.2222 | 1.018 | -2.000 | 2.000 |

| <u>Variable</u> | <u>Training Group</u> | <u>No. Pts.</u> | <u>Mean</u> | <u>Standard Deviation</u> | <u>Minimum Value</u> | <u>Maximum Value</u> |
|-----------------|-----------------------|-----------------|-------------|---------------------------|----------------------|----------------------|
| 104 | 0 | 50 | 0.2400 | 1.271 | -3.000 | 3.000 |
| 104 | 1 | 10 | -0.3000 | 1.252 | -2.000 | 1.000 |
| 104 | 2 | 9 | 1.056 | 1.261 | -1.000 | 3.000 |
| 104 | 3 | 13 | 0.2692 | 0.9920 | -1.000 | 2.000 |
| 104 | 4 | 18 | 0.1111 | 1.356 | -3.000 | 2.000 |
| 105 | 0 | 50 | 0.1700 | 1.141 | -3.000 | 3.000 |
| 105 | 1 | 10 | -0.3500 | 1.156 | -2.000 | 2.000 |
| 105 | 2 | 9 | 0.7222 | 0.7546 | -0.5000 | 2.000 |
| 105 | 3 | 13 | 0.3462 | 0.8987 | -1.000 | 2.000 |
| 105 | 4 | 18 | 0.5556E-01 | 1.360 | -3.000 | 3.000 |
| 106 | 0 | 51 | 0.5980 | 0.9951 | -3.000 | 3.000 |
| 106 | 1 | 10 | 0.4500 | 0.7619 | -0.5000 | 2.000 |
| 106 | 2 | 9 | 1.222 | 0.8333 | 0.0000 | 2.500 |
| 106 | 3 | 14 | 0.5000 | 0.7845 | -1.000 | 2.000 |
| 106 | 4 | 18 | 0.4444 | 1.247 | -3.000 | 3.000 |
| 107 | 0 | 55 | 1.164 | 2.974 | -6.000 | 8.000 |
| 107 | 1 | 9 | -0.6667 | 3.162 | -6.000 | 4.000 |
| 107 | 2 | 10 | 1.300 | 2.751 | -3.000 | 6.000 |
| 107 | 3 | 16 | 1.750 | 2.720 | -5.000 | 7.000 |
| 107 | 4 | 20 | 1.450 | 3.086 | -4.000 | 8.000 |

APPENDIX E

ADDITIONAL MULTIVARIATE ANALYSES

This appendix presents the results of applying factor analysis and discriminant analysis to the data obtained in the Stall Awareness Training Study. These tests were conducted as part of the statistical analysis of the data, but were not discussed in Section 5 since the results were inconclusive.

E.1 FACTOR ANALYSIS

This analysis technique can be used to determine, from a set of physically observed variables, a reduced set of "latent" variables which describe most of the variance in the data. The number of latent variables can be selected intrinsically, or they can be chosen to explain a specified proportion of the total variance in the original observations. The resulting factors can then be interpreted by the analyst in terms of the importance of the original variables, related variables, etc. Factor analysis thus provides insight into the relative importance and correlation among the observed variables.

Factor analysis was applied to a subset of the original observed variables. Six latent variables were found which explained 80 percent of the variance in the observed data. Table E-1 shows the original variables, and indicates the major elements of the factor matrix which relates the latent variables to the original variables. The interpretation of the latent variables in Table E-1 is relatively straight-forward for this example. The first latent variable is highly correlated with all of the evaluation pilots' subjective scores, and can therefore be construed as a subjective evaluation factor. Latent variable 2 describes pilot experience in terms of log total time, while latent variable 4 correlates primarily with the subject's recency. The third latent variable could be considered a slow flight performance factor. Latent variable 6 essentially

TABLE E-1. MAJOR ELEMENTS OF THE SORTED FACTOR MATRIX
(80 PERCENT VARIANCE).

| Original Observed Variable* | Latent Variable | | | | | |
|---|-----------------|---|---|---|---|---|
| | 1 | 2 | 3 | 4 | 5 | 6 |
| Log (TT at Evaluation #1) | | • | | | | |
| Recency at Evaluation #1 | | | | • | | |
| Log (TT at Evaluation #2) | | • | | | | |
| Recency at Evaluation #2) | | | | • | | |
| Δ Average Intentional Stall Performance | • | | | | | |
| Δ Unintentional Spins | | | | | • | |
| Δ Normalized Time Out of Slow Flight | | | • | | | |
| Δ Normalized # Times Out of Slow Flight | | | • | | | |
| Δ Rudder Coordination | | | | | | |
| Δ Altitude Control | • | | | | | |
| Δ Heading Control | • | | | | | |
| Δ Subjective Evaluation Grade | • | | | | | |
| Δ Written Quiz Grade | | | | | | • |
| Subjective Improvement Grade | • | | | | | |

*TT - Total Time.

Δ - Change in score between first and second evaluation flights.

• - Major element of factor matrix.

describes the change in written quiz grades, while variable 5 is basically an unintentional spin improvement variable.

E.2 DISCRIMINANT ANALYSIS

Another statistical method used in analyzing the data was a stepwise discriminant analysis. This technique identifies a subset of the observation variables which best classifies the data into specified groups, such as the four training groups.

Using the same variables as in the correlation analysis of Section 5, the most significant ones for distinguishing among the training groups are, in order of importance:

1. Δ Spin Experience
2. Log Total Time at Evaluation #1
3. Recency at Evaluation #2
4. Δ Unintentional Spins
5. Evaluation Improvement Score
6. Δ Recency
7. Δ Heading Control
8. Δ Subjective Evaluation Score

The resulting discriminant function was used to reclassify the subjects based on their observed performance, as shown in Table E-2. With this data, the discriminant function misclassified only two subjects (5 percent) - one each from training Groups 1 and 4 were incorrectly placed in Group 3.

Several of the variables used above do not reflect the subjects' performance as a result of the training increment, but describe their experience level. For example, the most significant variable--change in spin experience--is a "dead give away" for Group 4 subjects. Consequently, the discriminant analysis was repeated by omitting the experience variables (log total time, recency, and spin experience). The most

TABLE E-2. DISCRIMINANT FUNCTION RESULTS WITH EXPERIENCE DATA.

| Actual Training Group | Number of Subjects Classified Into Group | | | |
|-----------------------|--|---|----|----|
| | 1 | 2 | 3 | 4 |
| 1 | 6 | 0 | 1 | 0 |
| 2 | 0 | 9 | 0 | 0 |
| 3 | 0 | 0 | 11 | 0 |
| 4 | 0 | 0 | 1 | 13 |

significant variables for classification without the experience data are:

1. Evaluator's Improvement Grade
2. Δ Unintentional Spins
3. Δ Subjective Evaluation Grade
4. Δ Heading Coordination
5. Δ Normalized Times Out of Slow Flight
6. Δ Rudder Coordination.

Using this discriminant function to classify the original data yields the results in Table E-3. In this case, the discrimination is much less accurate, with seventeen subjects incorrectly classified. However, 59 percent of the subjects were correctly identified by their change in performance on the flight evaluations. (Random guessing would only identify 25 percent.)

The discriminant analysis method was also used to evaluate differences between the subjects from the two flight schools (e.g., differences between the two types of training aircraft). The most significant variables were:

1. Δ Altitude Control
2. Δ Recency
3. Δ Rudder Coordination
4. Δ Average Intentional Stall Performance

TABLE E-3. DISCRIMINANT FUNCTION RESULTS WITHOUT EXPERIENCE DATA.

| Actual Training Group | Number of Subjects Classified Into Group | | | |
|-----------------------|--|---|---|---|
| | 1 | 2 | 3 | 4 |
| 1 | 5 | 0 | 1 | 1 |
| 2 | 0 | 7 | 2 | 0 |
| 3 | 1 | 2 | 6 | 2 |
| 4 | 3 | 1 | 4 | 6 |

Using the discriminant function to classify the original data led to the results shown in Table E-4. Ninety-three percent of the students were correctly classified, while 7 percent were incorrectly identified with the wrong flight school.

The students in the Cessna aircraft generally showed significantly more improvement than their counterparts in the Piper. This might be explained partially by the slow flight characteristics of the two aircraft: the low-wing Cherokee is heavier and more stable than the Cessna 150, and it tends to mush rather than stall cleanly. Consequently, the first exposure to the evaluation flight was less difficult in the Piper, giving those subjects less room for improvement on the second evaluation.

TABLE E-4. DISCRIMINANT FUNCTION RESULTS FOR TRAINING AIRCRAFT TYPE.

| Actual Training Aircraft | Number of Subjects Classified by Training (Aircraft Type) | |
|--------------------------|---|-------|
| | PA-28 | C-150 |
| PA-28 | 25 | 1 |
| C-150 | 2 | 13 |